

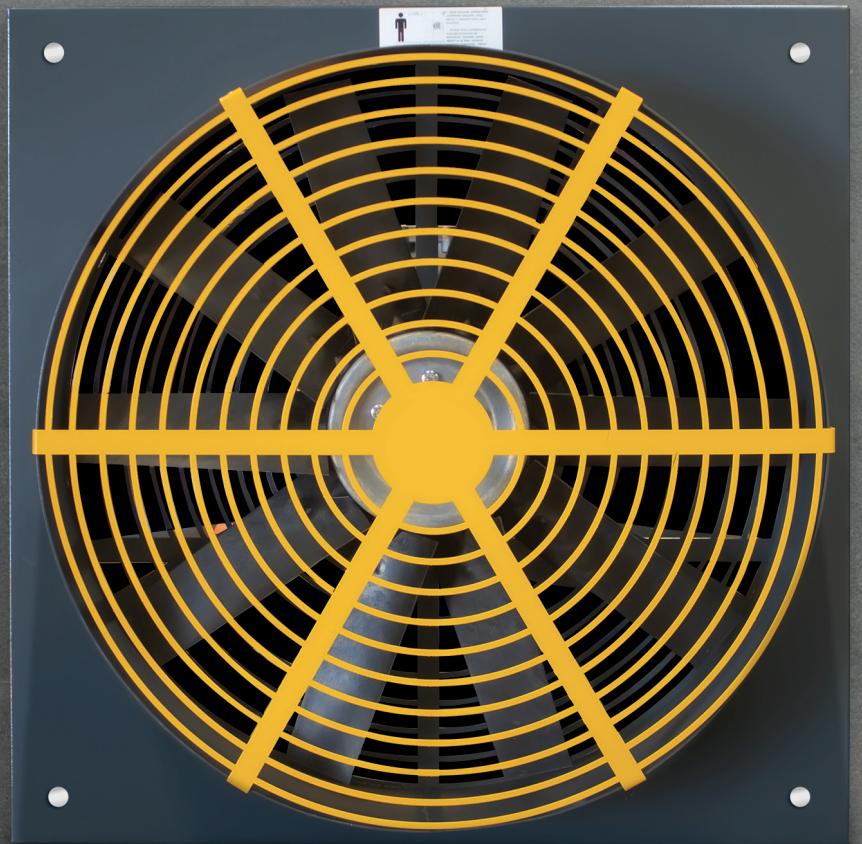

**AXIAL  
FANS**



## Axial Fans Models

MA-DF

---

MA-BF

---

MA-WF

---

MA-HF

---

MFA

---

MAP

---

MA-WF MA-WFS

---

MAP-BD

---

MAW

---

MAW-S

---



Options On Request



Anti Corrosion Fans



Ex-Proof

Motor Insulation Class	Motor Protection Class	Body Material	Impeller Material	Working Temperature	Standards
F Class	IP55	ST37	PPG / ALU	80 °C	ISO 9001

# MA-DF

## DUCT TYPE AXIAL FAN

MA-DF Serie fans can be used in exhaust or supply fresh air applications. Can be mounted in duct( in between or end with) and adjustable blade angles provide variable air flow options for every size.

## Technical Information

	Model Type	Max m <sup>3</sup> /h	Max Pa.	m/sc	kW	rpm d/d	A	Hz	Voltage	Sound dB	Max. Degree	Kg. Max.
3H PPG WING	MA-DF 310/4K 40-6	2350	75	8,2	0,18	1450	0,58	50	380	93	-30+90	87
	MA-DF 350/4K 45-6	3500	75	10,4	0,25	1450	0,81	50	380	94	-30+90	93
	MA-DF 400/4K 45-6	5000	100	11,4	0,25	1450	0,81	50	380	86	-30+90	95
	MA-DF 450/4K 45-6	7000	125	12,8	0,37	1450	1,2	50	380	92	-30+90	116
	MA-DF 500/4K 45-6	9400	150	13,5	0,55	1450	1,2	50	380	93	-30+90	123
	MA-DF 560/4K 45-6	12500	175	10,8	0,75	1450	2,1	50	380	94	-30+90	125
	MA-DF 560/4K 50-8	14700	200	12,8	1,5	1450	3,6	50	380	81	-30+90	155
	MA-DF 630/4K 45-8	16200	230	12,9	1,5	1450	2,7	50	380	98	-30+90	170
	MA-DF 630/4K 45-10	18800	250	16,9	2,2	1450	5,3	50	380	98	-30+90	178
4Z PPG WING	MA-DF 710/4K 32,5-6	20000	250	15,1	2,2	1450	5,3	50	380	89	-30+90	220
	MA-DF 710/4K 40-6	25000	250	18,4	3	1450	6,6	50	380	90	-30+90	329
	MA-DF 710/4K 45-6	28500	250	20,3	4	1450	8,7	50	380	93	-30+90	372
5Z PPG WING	MA-DF 800/4K 40-6	32000	300	19,5	5,5	1450	8,7	50	380	95	-30+90	439
	MA-DF 800/4K 45-6	37000	350	21,6	5,5	1450	11,8	50	380	96	-30+90	458
	MA-DF 800/4K 45-9	40000	350	23,5	7,5	1450	15,8	50	380	98	-30+90	665
	MA-DF 900/4K 40-6	45000	350	20,5	7,5	1450	15,8	50	380	97	-30+90	785
	MA-DF 1000/4K 37,5-6	50000	350	20	7,5	1450	15,8	50	380	95	-30+90	665

### FAN SELECTION CHART

Model Type	25Pa	50Pa	75Pa	100Pa	125Pa	150Pa	175Pa	200Pa	250Pa	300Pa	350Pa	400Pa
MA-DF 310/4K 40-6	2100	1130	1400	-	-	-	-	-	-	-	-	-
MA-DF 350/4K 45-6	3000	2500	2000	-	-	-	-	-	-	-	-	-
MA-DF 400/4K 45-6	4500	4100	3500	3150	-	-	-	-	-	-	-	-
MA-DF 450/4K 45-6	5800	5350	5000	4100	3350	-	-	-	-	-	-	-
MA-DF 500/4K 45-6	8000	7000	6550	6150	5700	5000	-	-	-	-	-	-
MA-DF 560/4K 45-6	11500	11000	10500	10000	9000	8000	6700	-	-	-	-	-
MA-DF 560/4K 50-8	14000	13000	12000	11000	10500	10000	8500	5800	-	-	-	-
MA-DF 630/4K 45-8	14000	13330	12000	11400	10700	9700	8300	5100	-	-	-	-
MA-DF 630/4K 45-10	18200	18000	17000	16500	16000	15500	15000	14500	13000	-	-	-
MA-DF 710/4K 32,5-6	21000	20000	19200	19000	18000	17000	16000	15300	13700	-	-	-
MA-DF 710/4K 40-6	25000	24000	23000	22000	20000	19000	17500	16500	16000	-	-	-
MA-DF 710/4K 45-6	28000	27500	26000	25000	24500	24000	23000	22000	19000	11500	-	-
MA-DF 800/4K 40-6	34000	33000	32500	32000	31000	30000	29000	27000	25500	22000	15000	-
MA-DF 800/4K 45-6	38000	37000	36000	35000	34000	33500	32500	31000	28000	190000	15000	-
MA-DF 800/4K 45-9	41000	40500	40000	39000	38000	37000	36000	35000	34000	31500	29000	16500
MA-DF 900/4K 40-6	46000	45000	44000	43000	42000	41500	40000	39000	36500	35000	31000	22000
MA-DF 1000/4K 37,5-6	55000	54000	53000	52000	51000	50000	39000	47000	45000	42500	40000	35000

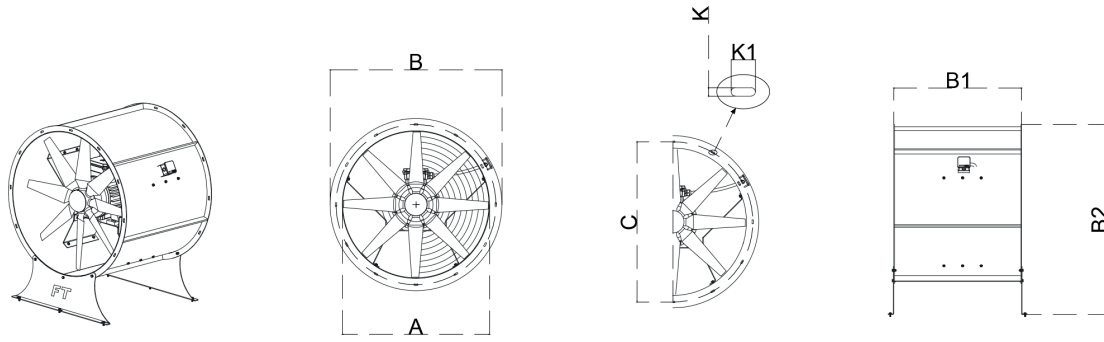

### BODY DIMENSIONS

Model Type	A	B	B1	B2	C	K	K1
MA-DF 310	310	395	350	455	355	Ø 9x8 Ad.	20
MA-DF 350	350	430	350	590	390	Ø 9x8 Ad.	20
MA-DF 400	400	480	400	540	440	Ø 9x8 Ad.	20
MA-DF 450	450	530	450	490	490	Ø 9x8 Ad.	20
MA-DF 500	500	580	450	640	540	Ø 9x8 Ad.	20
MA-DF 560	560	640	500	700	600	Ø 9x8 Ad.	20
MA-DF 630	630	730	500	780	680	Ø 11x10 Ad.	30
MA-DF 710	710	810	500	860	760	Ø 11x10 Ad.	30
MA-DF 800	800	900	500	950	850	Ø 11x10 Ad.	30
MA-DF 900	900	1000	500	1050	950	Ø 11x10 Ad.	30
MA-DF 1000	1000	1100	500	1150	1050	Ø 13x14 Ad.	30
MA-DF 1120	1120	1120	550	1270	1170	Ø 13x14 Ad.	40
MA-DF 1250	1250	1350	600	1400	1300	Ø 13x14 Ad.	40
MA-DF 1400	1400	1500	600	1550	1450	Ø 13x14 Ad.	40
MA-DF 1600	1600	1700	600	1750	1650	Ø 13x16 Ad.	50
MA-DF 1800	1800	1900	600	1950	1850	Ø 13x18 Ad.	50
MA-DF 2000	2000	2100	600	2150	2050	Ø 13x18 Ad.	50

## Pressure Curves

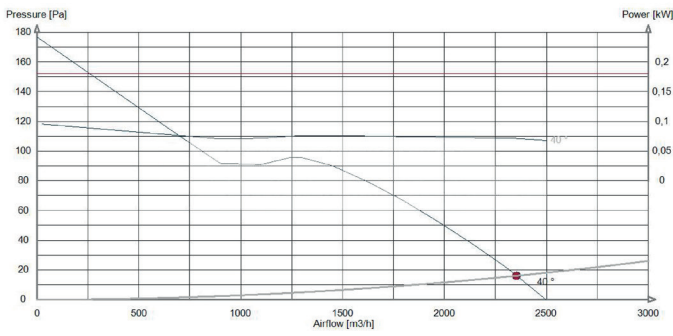

MA-DF 310/4K 40-6

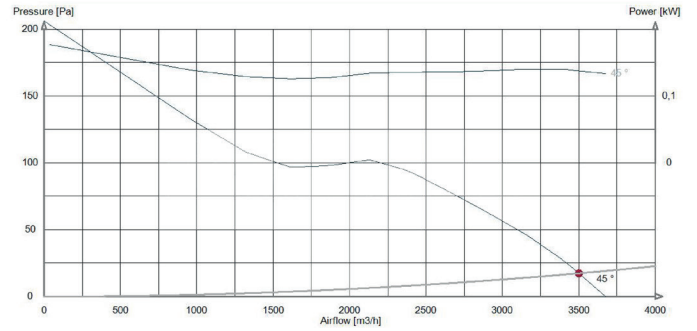

MA-DF 350/4K 45-6

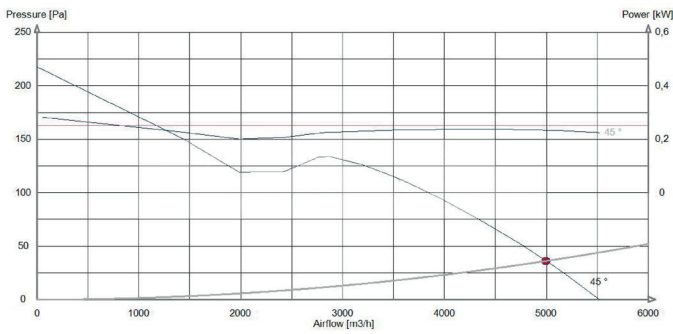

MA-DF 400/4K 45-6

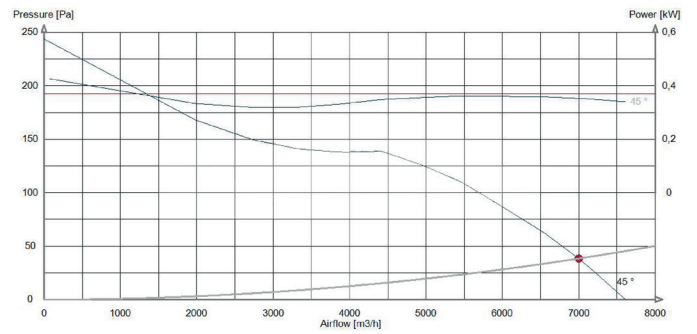

MA-DF 450/4K 45-6

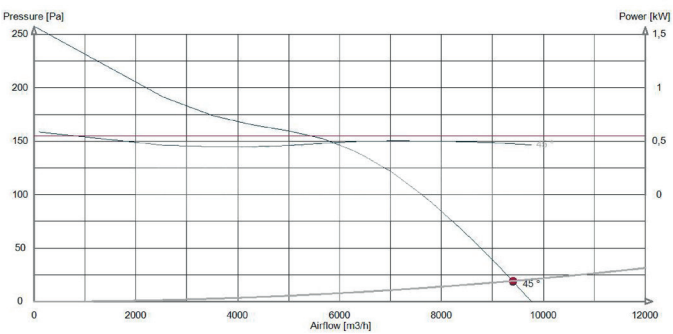

MA-DF 500/4K 45-6

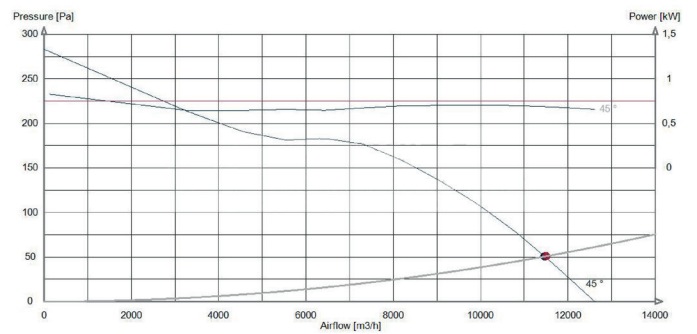

MA-DF 560/4K 45-6

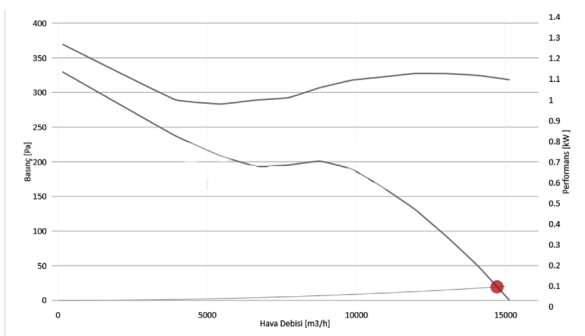

MA-DF 560/4K 50-8

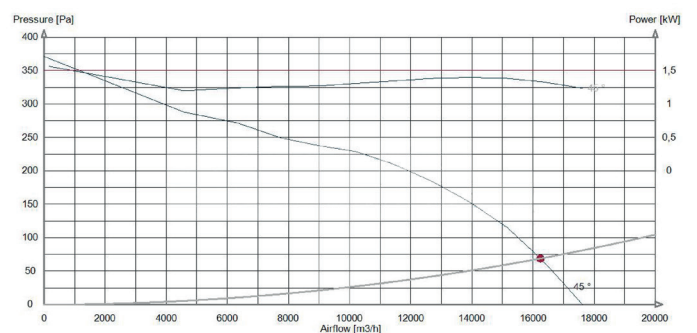

MA-DF 630/4K 45-8

Pressure Curves

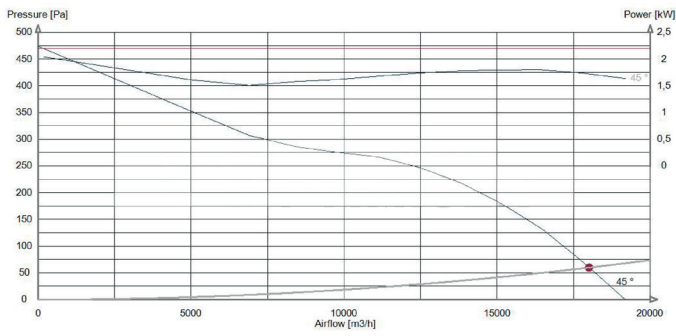

MA-DF630/4K 45-10

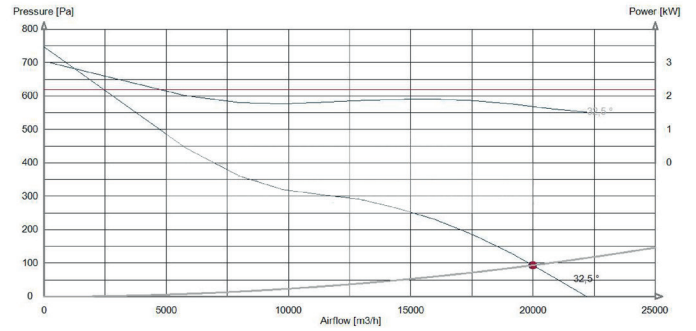

MA-DF 710/4K 32,5-5-6

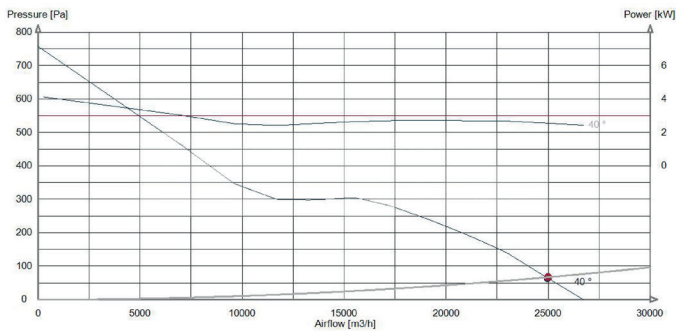

MA-DF 710/4K 40-6

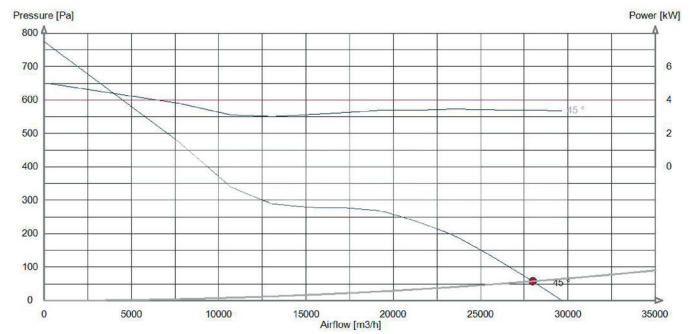

MA-DF 710/4K 45-6

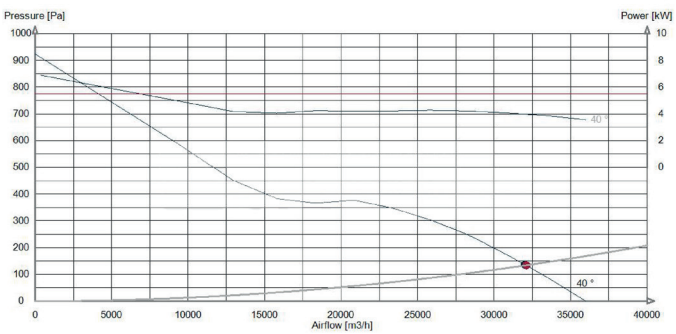

MA-DF 800/4K 40-6

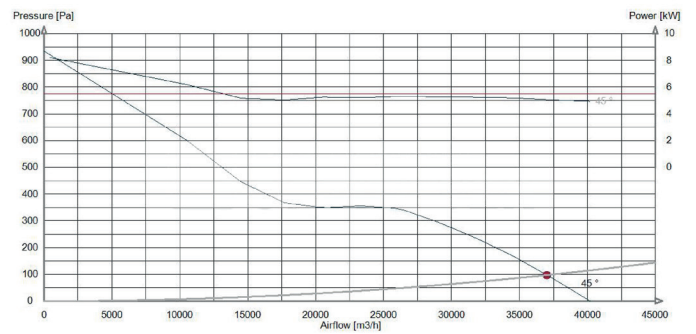

MA-DF 800/4K 45-6

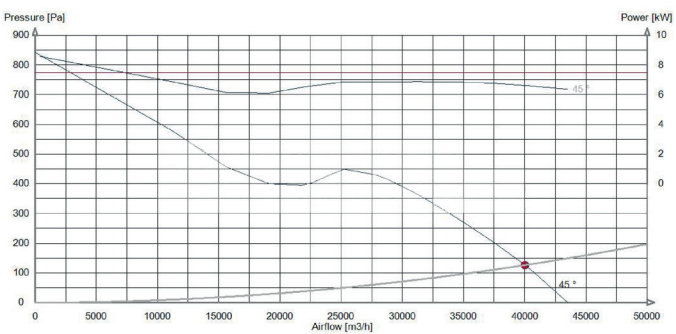

MA-DF 800/4K 45-9

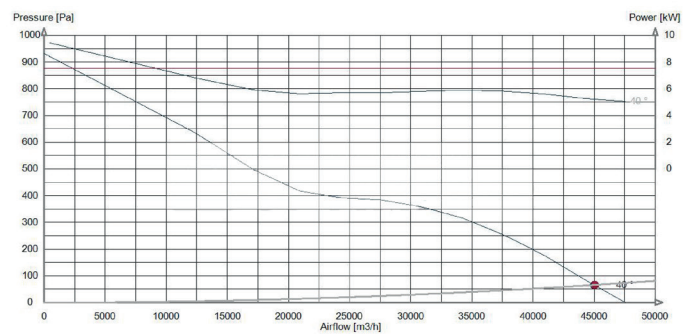

MA-DF 900/4K 40-6

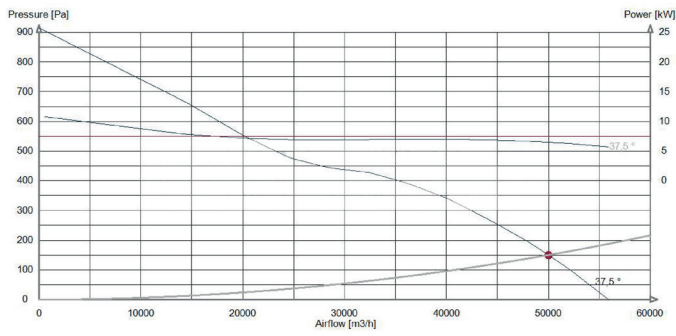

MA-DF 1000/4K 37,5-6





Options On Request



Ex-Proof

**F300**

F300°C/2h

Motor Insulation Class	Motor Protection Class	Body Material	Impeller Material	Working Temperature	Standards
F Class	IP55	ST37	PPG / ALU	80 °C	ISO 9001

# MA-BF

## BIFURCATED CASE AXIAL FANS

MA-BF Serie Bifurcated Case Axial fans has been designed to handle hostile air conditions. Isolating the motor from the system airstream, the bifurcated fan can transport a wide variety of saturated and dustladen atmospheres, heated air and hot gases.

## Technical Information

	Model Type	Max m³/h	Max Pa.	m/sc	kW	rpm d/d	A	Hz	Voltage	Sound dB	Max. Degree
3H PPG WING	MA-BF 310/4K 40-6	2350	75	8,2	0,18	1450	0,58	50	380	93	-30+90
	MA-BF 350/4K 45-6	3500	75	10,4	0,25	1450	0,81	50	380	94	-30+90
	MA-BF 400/4K 45-6	5000	100	11,4	0,25	1450	0,81	50	380	86	-30+90
	MA-BF 450/4K 45-6	7000	125	12,8	0,37	1450	1,2	50	380	92	-30+90
	MA-BF 500/4K 45-6	9400	150	13,5	0,55	1450	1,2	50	380	93	-30+90
	MA-BF 560/4K 45-6	12500	175	10,8	0,75	1450	2,1	50	380	94	-30+90
	MA-BF 560/4K 50-8	14700	200	12,8	1,5	1450	3,6	50	380	81	-30+90
	MA-BF 630/4K 45-8	16200	230	12,9	1,5	1450	2,7	50	380	98	-30+90
	MA-BF 630/4K 45-10	18800	250	16,9	2,2	1450	5,3	50	380	98	-30+90
4Z PPG WING	MA-BF 710/4K 32,5-6	20000	250	15,1	2,2	1450	5,3	50	380	89	-30+90
	MA-BF 710/4K 40-6	25000	250	18,4	3	1450	6,6	50	380	90	-30+90
	MA-BF 710/4K 45-6	28500	250	20,3	4	1450	8,7	50	380	93	-30+90
5Z PPG WING	MA-BF 800/4K 40-6	32000	300	19,5	5,5	1450	8,7	50	380	95	-30+90
	MA-BF 800/4K 45-6	37000	350	21,6	5,5	1450	11,8	50	380	96	-30+90
	MA-BF 800/4K 45-9	40000	350	23,5	7,5	1450	15,8	50	380	98	-30+90
	MA-BF 900/4K 40-6	45000	350	20,5	7,5	1450	15,8	50	380	97	-30+90
	MA-BF 1000/4K 37,5-6	50000	350	20	7,5	1450	15,8	50	380	95	-30+90

### FAN SELECTION CHART

Model Type	25Pa	50Pa	75Pa	100Pa	125Pa	150Pa	175Pa	200Pa	250Pa	300Pa	350Pa	400Pa
MA-BF 310/4K 40-6	2100	1130	1400	-	-	-	-	-	-	-	-	-
MA-BF 350/4K 45-6	3000	2500	2000	-	-	-	-	-	-	-	-	-
MA-BF 400/4K 45-6	4500	4100	3500	3150	-	-	-	-	-	-	-	-
MA-BF 450/4K 45-6	5800	5350	5000	4100	3350	-	-	-	-	-	-	-
MA-BF 500/4K 45-6	8000	7000	6550	6150	5700	5000	-	-	-	-	-	-
MA-BF 560/4K 45-6	11500	11000	10500	10000	9000	8000	6700	-	-	-	-	-
MA-BF 560/4K 50-8	14000	13000	12000	11000	10500	10000	8500	5800	-	-	-	-
MA-BF 630/4K 45-8	14000	13330	12000	11400	10700	9700	8300	5100	-	-	-	-
MA-BF 630/4K 45-10	18200	18000	17000	16500	16000	15500	15000	14500	13000	-	-	-
MA-BF 710/4K 32,5-6	21000	20000	19200	19000	18000	17000	16000	15300	13700	-	-	-
MA-BF 710/4K 40-6	25000	24000	23000	22000	20000	19000	17500	16500	16000	-	-	-
MA-BF 710/4K 45-6	28000	27500	26000	25000	24500	24000	23000	22000	19000	11500	-	-
MA-BF 800/4K 40-6	34000	33000	32500	32000	31000	30000	29000	27000	25500	22000	15000	-
MA-BF 800/4K 45-6	38000	37000	36000	35000	34000	33500	32500	31000	28000	190000	15000	-
MA-BF 800/4K 45-9	41000	40500	40000	39000	38000	37000	36000	35000	34000	31500	29000	16500
MA-BF 900/4K 40-6	46000	45000	44000	43000	42000	41500	40000	39000	36500	35000	31000	22000
MA-BF 1000/4K 37,5-6	55000	54000	53000	52000	51000	50000	39000	47000	45000	42500	40000	35000

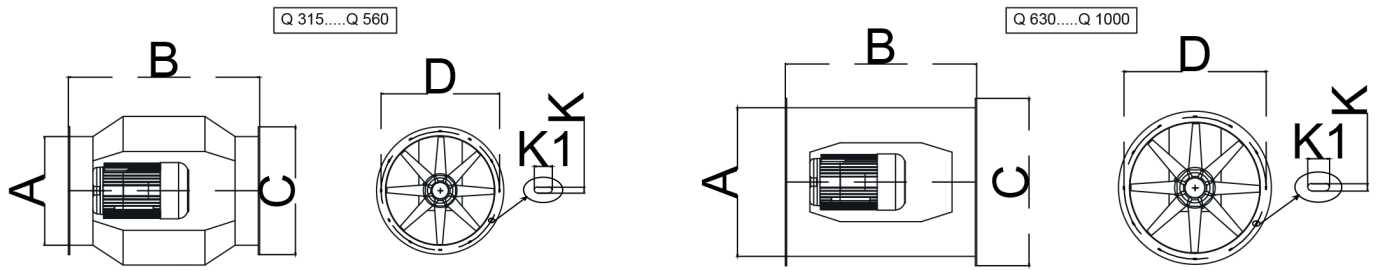

BODY DIMENSIONS

Model Type	A	B	C	D	K	K1
MA-BF 310	315	460	395	455	Ø 9x8 Ad.	20
MA-BF 350	350	460	430	590	Ø 9x8 Ad.	20
MA-BF 400	400	580	480	540	Ø 9x8 Ad.	20
MA-BF 450	450	640	530	490	Ø 9x8 Ad.	20
MA-BF 500	500	730	580	640	Ø 9x8 Ad.	20
MA-BF 560	560	730	640	700	Ø 9x8 Ad.	20
MA-BF 630	630	730	730	780	Ø 11x10 Ad.	30
MA-BF 710	710	770	810	860	Ø 11x10 Ad.	30
MA-BF 800	800	830	900	950	Ø 11x10 Ad.	30
MA-BF 900	900	850	1000	1050	Ø 11x10 Ad.	30
MA-BF 1000	1000	1270	1100	1150	Ø 13x14 Ad.	30

## Pressure Curves

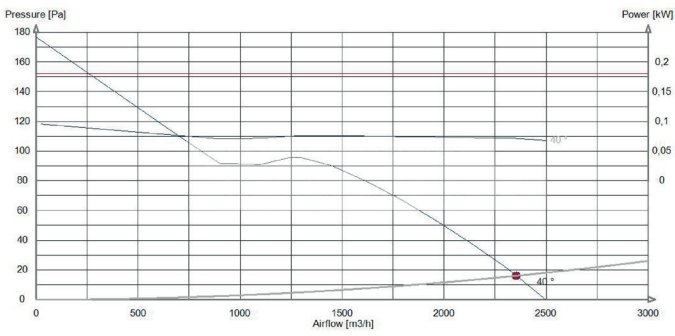

MA-BF 310/4K 40-6

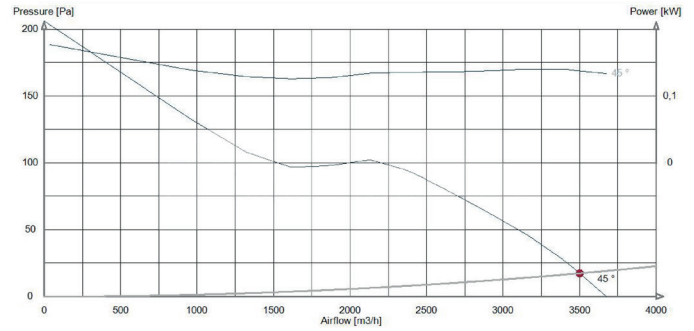

MA-BF 350/4K 45-6

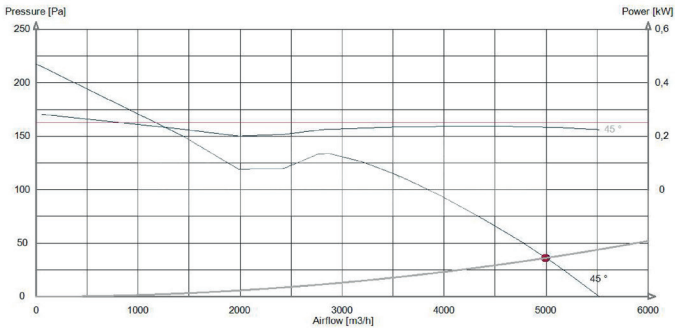

MA-BF 400/4K 45-6

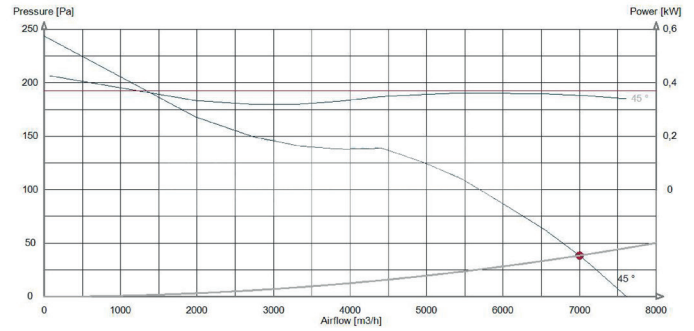

MA-BF 450/4K 45-6

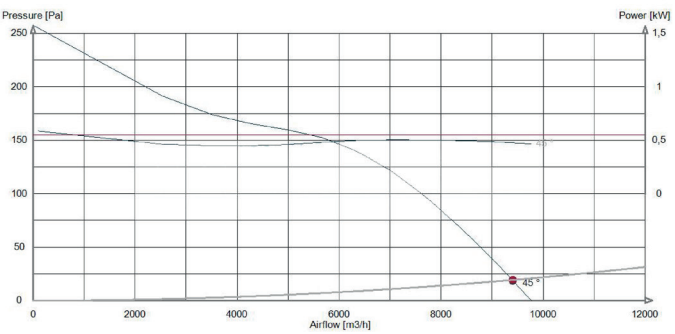

MA-BF 500/4K 45-6

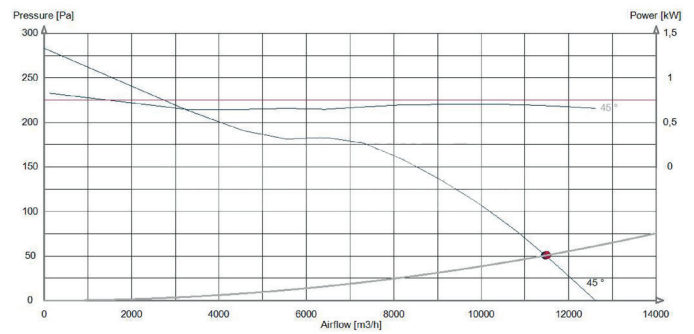

MA-BF 560/4K 45-6

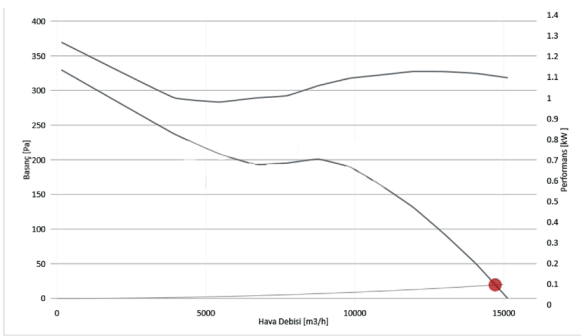

MA-BF 560/4K 50-8

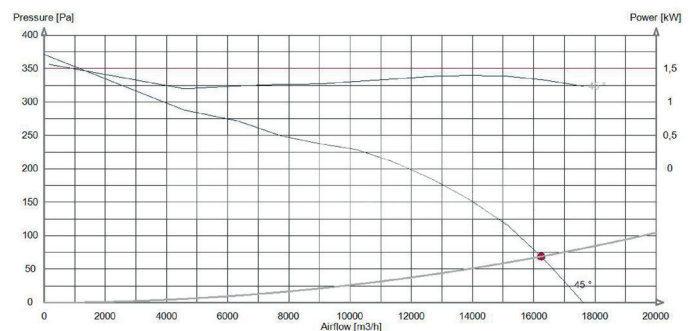

MA-BF 630/4K 45-8

Pressure Curves

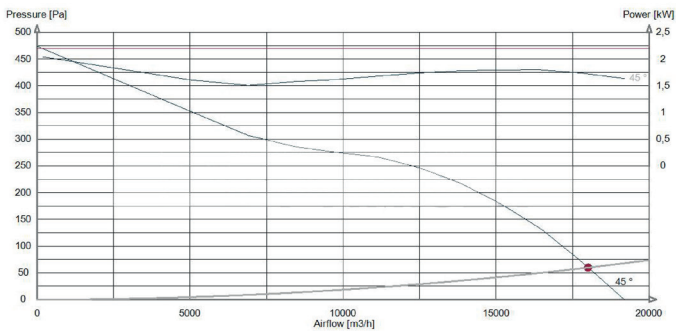

MA-BF 630/4K 45-10

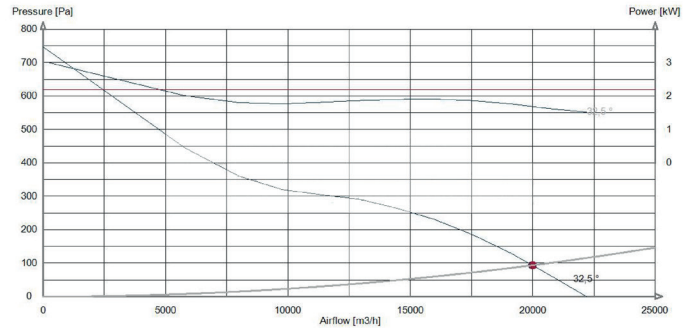

MA-BF 710/4K 32,5-6

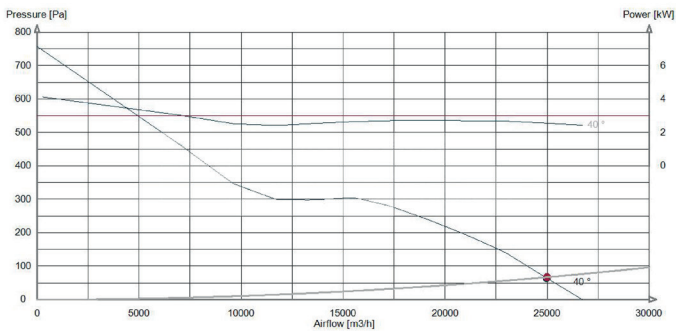

MA-BF 710/4K 40-6

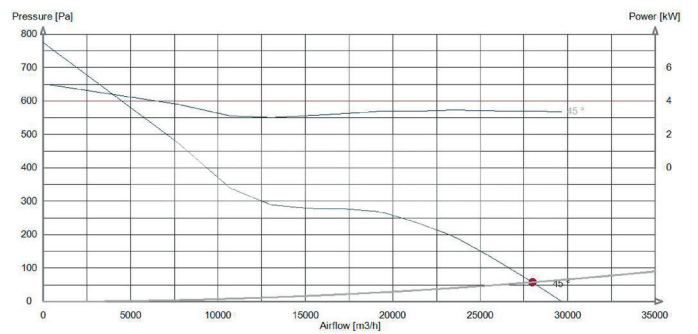

MA-BF 710/4K 45-6

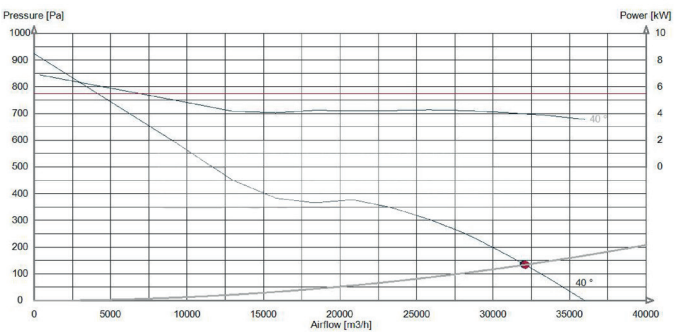

MA-BF 800/4K 40-6

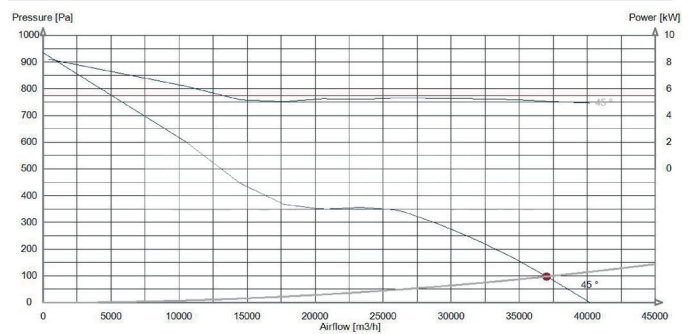

MA-BF 800/4K 45-6

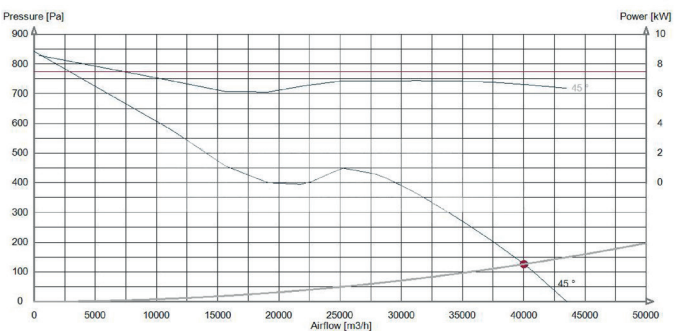

MA-BF 800/4K 45-9

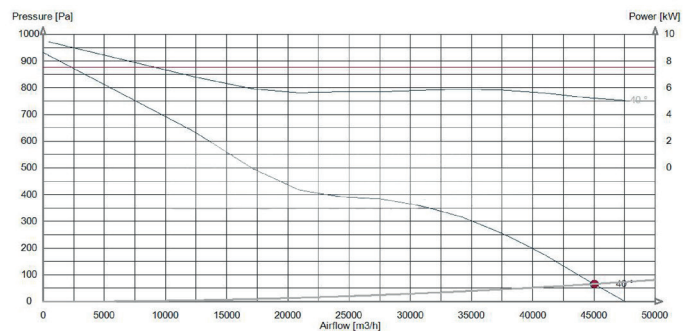

MA-BF 900/4K 40-6

## Pressure Curves

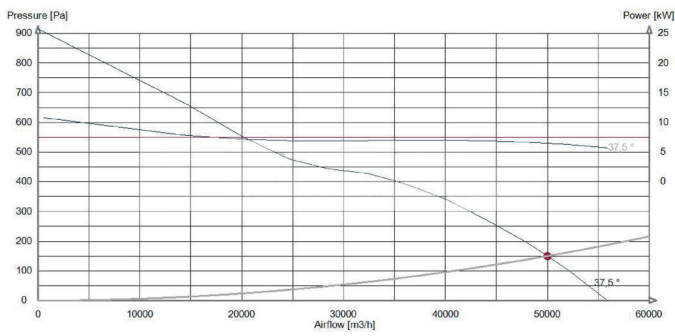

MA-BF 1000/4K 37,5-6



Options On Request



Anti Corrosion Fans



Ex-Proof

Motor Insulation Class	Motor Protection Class	Body Material	Impeller Material	Working Temperature	Standards
F Class	IP55	ST37	PPG / ALU	80 °C	ISO 9001

# MA-WF

## AXIAL WALL FANS

MA-WF Serie Axial Wall Fans are suitable for the ventilation of industrial stock farms, greenhouses, garages, gymnasiums, car parks. The axial impeller with profile blades in black plastic material and hub in die-cast aluminium alloy.

## Technical Information

	Model Type	Max m <sup>3</sup> /h	Max Pa.	m/sc	kW	rpm d/d	A	Hz	Voltage	Sound dB	Max. Degree
3H PPG WING	MA-WF 310/4K 40-6	2350	75	8,2	0,18	1450	0,58	50	380	93	-30+90
	MA-WF 350/4K 45-6	3500	75	10,4	0,25	1450	0,81	50	380	94	-30+90
	MA-WF 400/4K 45-6	5000	100	11,4	0,25	1450	0,81	50	380	86	-30+90
	MA-WF 450/4K 45-6	7000	125	12,8	0,37	1450	1,2	50	380	92	-30+90
	MA-WF 500/4K 45-6	9400	150	13,5	0,55	1450	1,2	50	380	93	-30+90
	MA-WF 560/4K 45-6	12500	175	10,8	0,75	1450	2,1	50	380	94	-30+90
	MA-WF 560/4K 50-8	14700	200	12,8	1,5	1450	3,6	50	380	81	-30+90
	MA-WF 630/4K 45-8	16200	230	12,9	1,5	1450	2,7	50	380	98	-30+90
	MA-WF 630/4K 45-10	18800	250	16,9	2,2	1450	5,3	50	380	98	-30+90
4Z PPG WING	MA-WF 710/4K 32,5-6	20000	250	15,1	2,2	1450	5,3	50	380	89	-30+90
	MA-WF 710/4K 40-6	25000	250	18,4	3	1450	6,6	50	380	90	-30+90
	MA-WF 710/4K 45-6	28500	250	20,3	4	1450	8,7	50	380	93	-30+90
5Z PPG WING	MA-WF 800/4K 40-6	32000	300	19,5	5,5	1450	8,7	50	380	95	-30+90
	MA-WF 800/4K 45-6	37000	350	21,6	5,5	1450	11,8	50	380	96	-30+90
	MA-WF 800/4K 45-9	40000	350	23,5	7,5	1450	15,8	50	380	98	-30+90
	MA-WF 900/4K 40-6	45000	350	20,5	7,5	1450	15,8	50	380	97	-30+90
	MA-WF 1000/4K 37,5-6	50000	350	20	7,5	1450	15,8	50	380	95	-30+90

### FAN SELECTION CHART

Model Type	25Pa	50Pa	75Pa	100Pa	125Pa	150Pa	175Pa	200Pa	250Pa	300Pa	350Pa	400Pa
MA-WF 310/4K 40-6	2100	1130	1400	-	-	-	-	-	-	-	-	-
MA-WF 350/4K 45-6	3000	2500	2000	-	-	-	-	-	-	-	-	-
MA-WF 400/4K 45-6	4500	4100	3500	3150	-	-	-	-	-	-	-	-
MA-WF 450/4K 45-6	5800	5350	5000	4100	3350	-	-	-	-	-	-	-
MA-WF 500/4K 45-6	8000	7000	6550	6150	5700	5000	-	-	-	-	-	-
MA-WF 560/4K 45-6	11500	11000	10500	10000	9000	8000	6700	-	-	-	-	-
MA-WF 560/4K 50-8	14000	13000	12000	11000	10500	10000	8500	5800	-	-	-	-
MA-WF 630/4K 45-8	14000	13330	12000	11400	10700	9700	8300	5100	-	-	-	-
MA-WF 630/4K 45-10	18200	18000	17000	16500	16000	15500	15000	14500	13000	-	-	-
MA-WF 710/4K 32,5-6	21000	20000	19200	19000	18000	17000	16000	15300	13700	-	-	-
MA-WF 710/4K 40-6	25000	24000	23000	22000	20000	19000	17500	16500	16000	-	-	-
MA-WF 710/4K 45-6	28000	27500	26000	25000	24500	24000	23000	22000	19000	11500	-	-
MA-WF 800/4K 40-6	34000	33000	32500	32000	31000	30000	29000	27000	25500	22000	15000	-
MA-WF 800/4K 45-6	38000	37000	36000	35000	34000	33500	32500	31000	28000	190000	15000	-
MA-WF 800/4K 45-9	41000	40500	40000	39000	38000	37000	36000	35000	34000	31500	29000	16500
MA-WF 900/4K 40-6	46000	45000	44000	43000	42000	41500	40000	39000	36500	35000	31000	22000
MA-WF 1000/4K 37,5-6	55000	54000	53000	52000	51000	50000	39000	47000	45000	42500	40000	35000



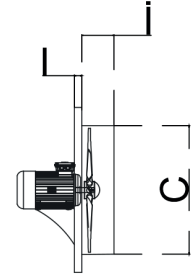
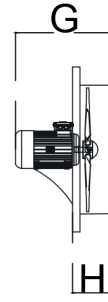
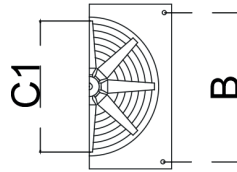
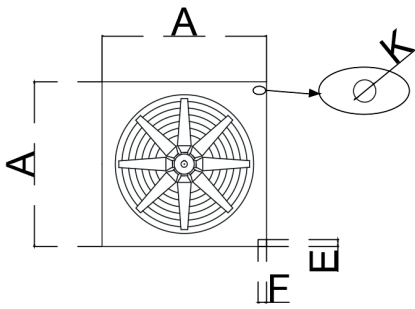

BODY DIMENSIONS

Model Type	A	B	C	C1	E	F	G	H	I	i	K
MA-WF 310	415	340	325	315	37,5	37,5	339	150	20	130	Ø9
MA-WF 350	465	390	365	355	37,5	37,5	408	150	20	130	Ø9
MA-WF 400	500	420	410	400	40	40	408	150	20	130	Ø9
MA-WF 450	560	480	460	450	40	40	408	150	20	130	Ø9
MA-WF 500	630	550	510	500	40	40	565	150	20	130	Ø9
MA-WF 560	700	620	570	560	40	40	565	150	20	130	Ø9
MA-WF 630	760	680	640	630	40	40	615	200	20	180	Ø11
MA-WF 710	810	730	720	710	40	40	688	200	20	180	Ø11
MA-WF 800	950	850	810	800	50	50	708	220	20	190	Ø11
MA-WF 900	1100	960	910	900	70	70	665	250	20	220	Ø11
MA-WF 1000	1200	1060	1010	1000	70	70	738	250	20	220	Ø11

## Pressure Curves

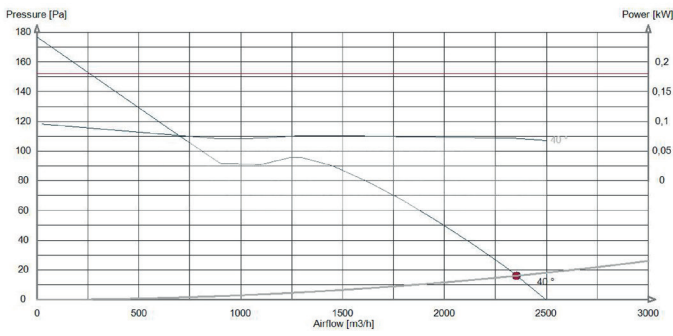

MA-WF 310/4K 40-6

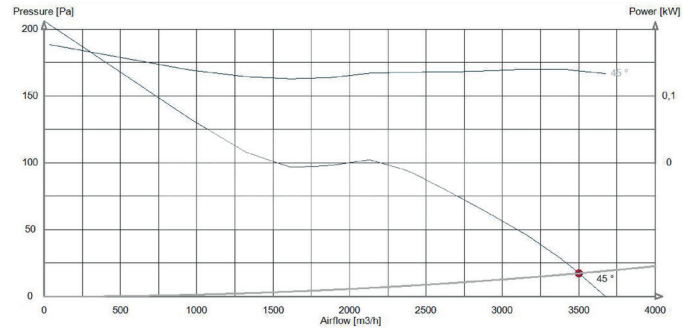

MA-WF 350/4K 45-6

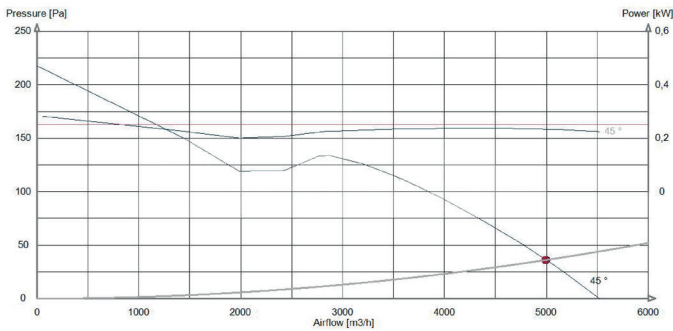

MA-WF 400/4K 45-6

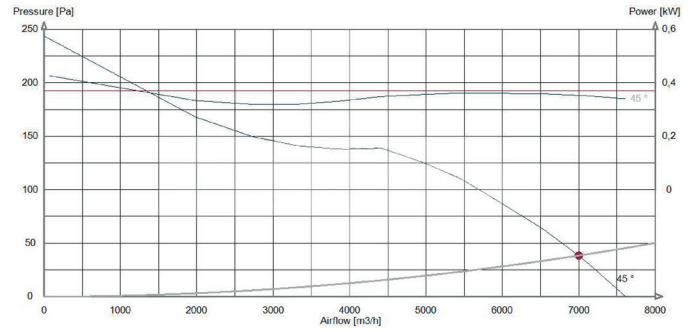

MA-WF 450/4K 45-6

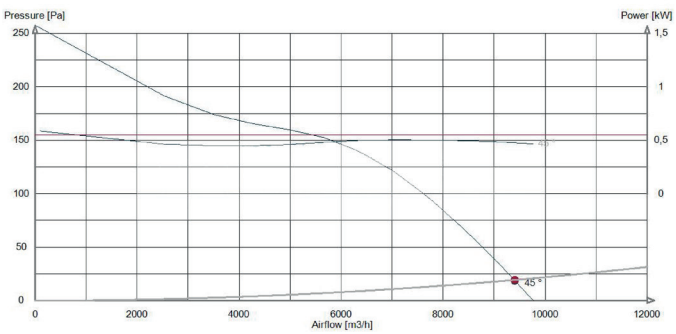

MA-WF 500/4K 45-6

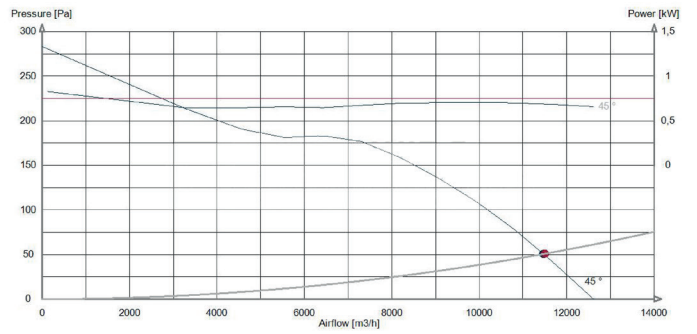

MA-WF 560/4K 45-6

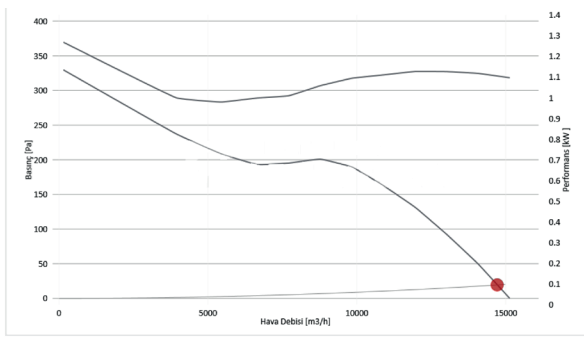

MA-WF 560/4K 50-8

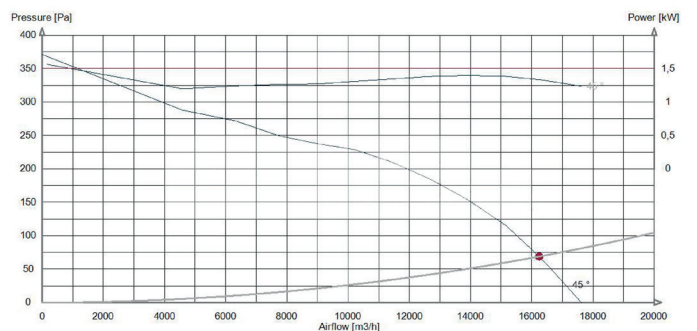

MA-WF 630/4K 45-8



Motor Insulation Class	Motor Protection Class	Body Material	Impeller Material	Working Temperature	Standards
F Class	IP55	ST37	PPG / ALU	80 °C	ISO 9001

# MA-HF

## AXIAL BOX FANS

MA-HF serie Axial box fans can be used in difficult montage systems with its multiple connection solutions. Having on-off switch and inbuilt sound attenuator.

## Technical Information

Model Type	Max m <sup>3</sup> /h	kW	rpm d/d	Hz	Voltage	Sound dB
MA-HF 400-5-25	2895	0,37	1450	50	380	60
MA-HF 450-5-25	4180	0,55	1456	50	380	61
MA-HF 500-5-25	5845	0,55	1453	50	380	62
MA-HF 560-5-25	8150	0,75	1466	50	380	63
MA-HF 630-5-30	13480	1,1	1465	50	380	64
MA-HF 710-5-30	19210	1,5	1472	50	380	65
MA-HF 800-5-30	25560	2,2	1459	50	380	67
MA-HF 800-5-35	30940	3	1463	50	380	69
MA-HF 900-5-35	39250	4	1471	50	380	71
MA-HF 900-5-40	44635	5,5	1472	50	380	73
MA-HF 1000-5-40	54570	7,5	1478	50	380	73
MA-HF 900-8-40	46200	11	1454	50	380	76
MA-HF 1000-8-40	62250	15	1456	50	380	77
MA-HF 1000-8-45	69070	18,5	1458	50	380	78
MA-HF 1120-8-40	86620	22	1471	50	380	79
MA-HF 1120-8-45	95270	30	1474	50	380	81

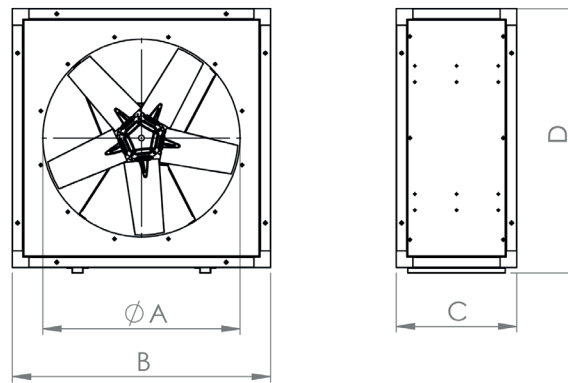

Model Type	A	B	C	D
MA-HF 400	400	620	425	645
MA-HF 450	450	670	425	695
MA-HF 500	500	720	425	745
MA-HF 560	560	780	425	805
MA-HF 630	630	850	425	875
MA-HF 710	710	930	425	955
MA-HF 800	800	1020	425	1045
MA-HF 900	900	1120	525	1145
MA-HF 1000	1000	1220	525	1245
MA-HF 1120	1120	1340	525	1365

Pressure Curves

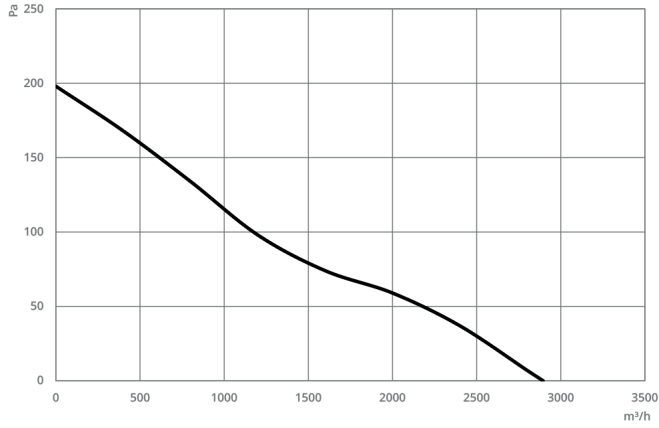

MA-HF 400-5-25

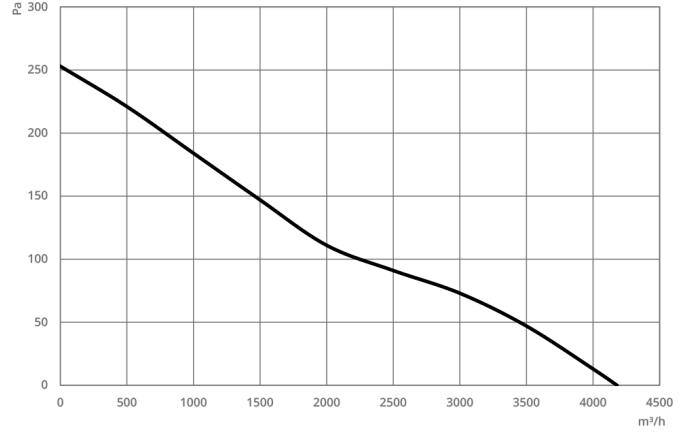

MA-HF 450-5-25

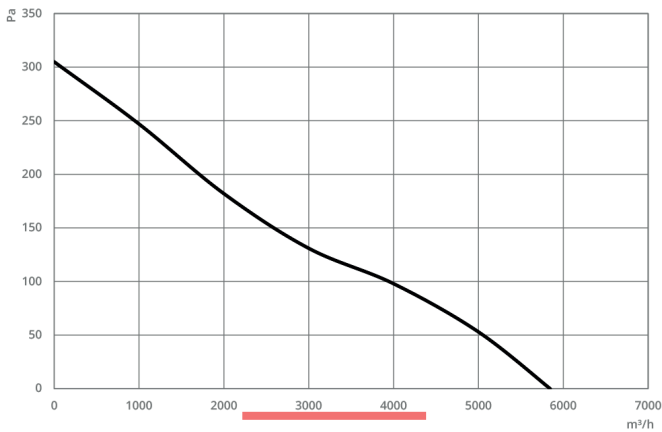

MA-HF 500-5-25

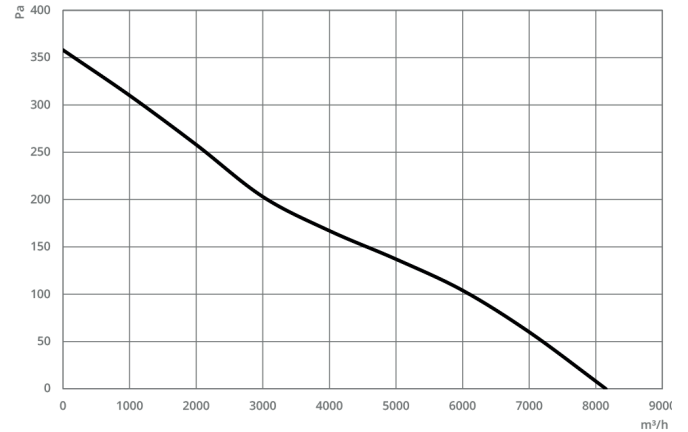

MA-HF 560-5-25

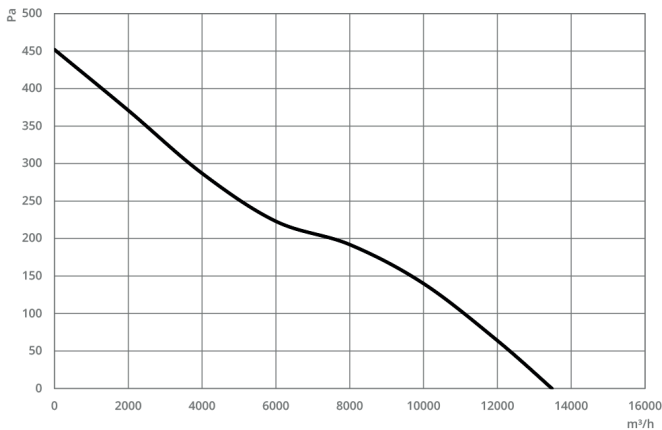

MA-HF 630-5-30

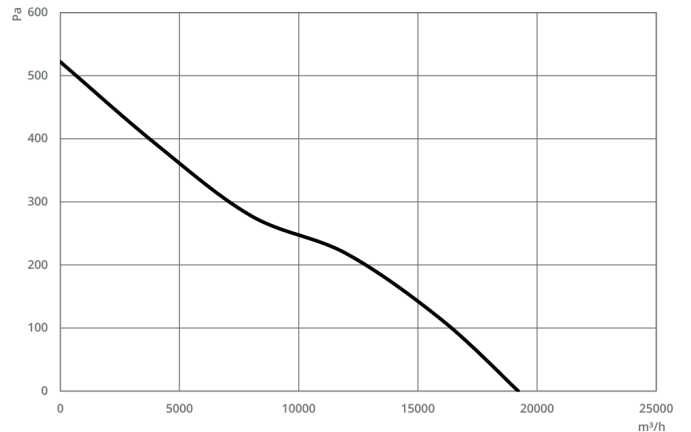

MA-HF 710-5-30

## Pressure Curves

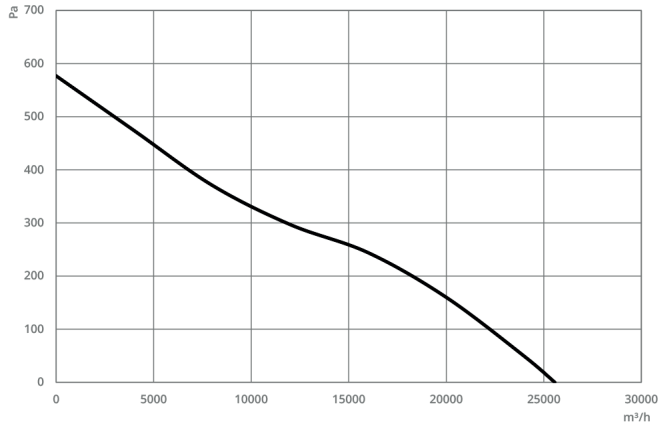

MA-HF 800-5-30

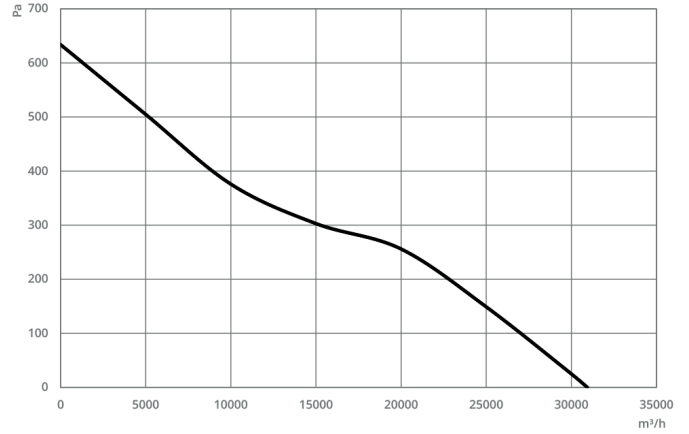

MA-HF 800-5-35

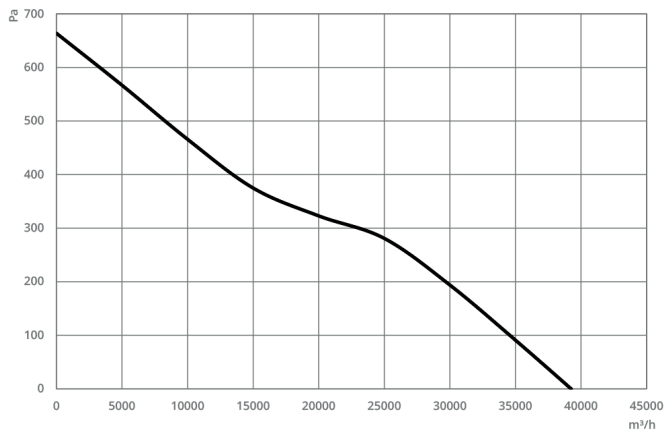

MA-HF 900-5-35

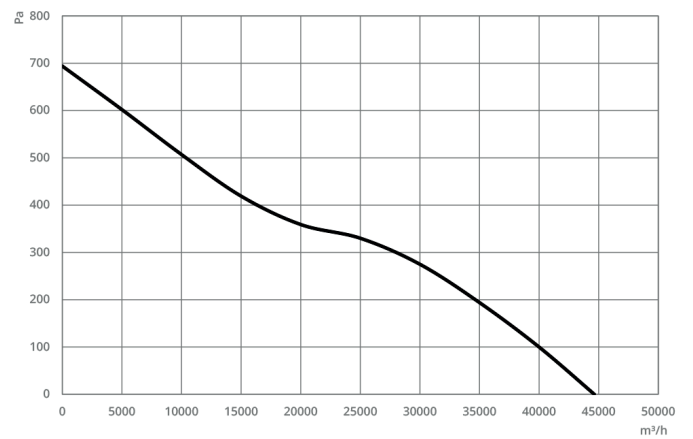

MA-HF 900-5-40

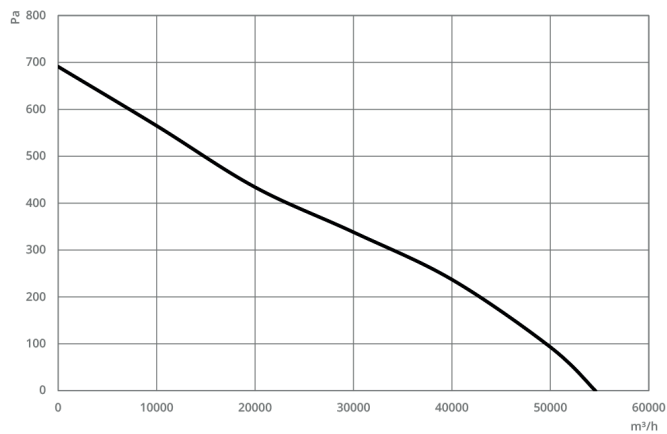

MA-HF 1000-5-40

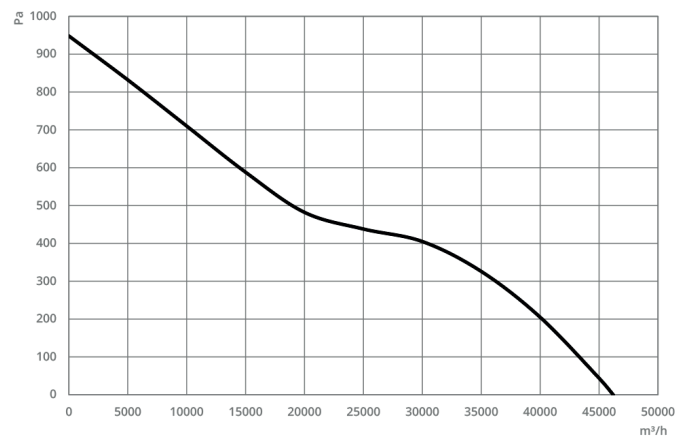

MA-HF 900-8-40



## Pressure Curves

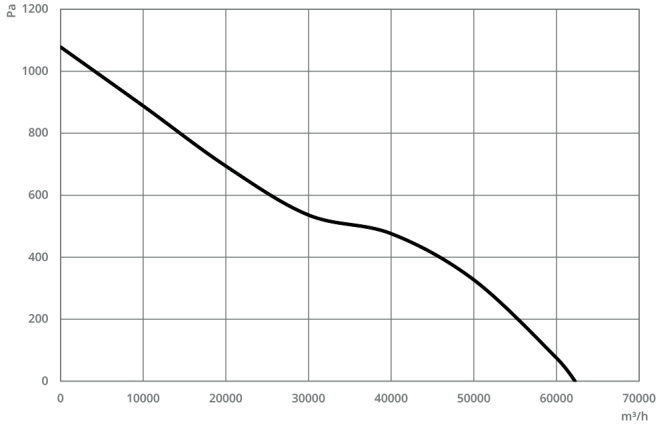

MA-HF 1000-8-40

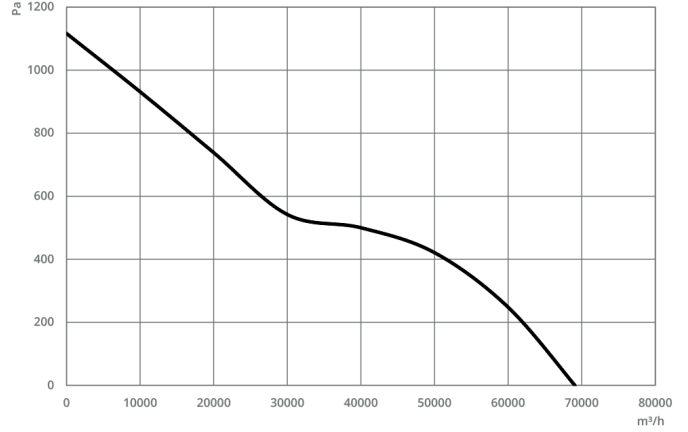

MA-HF 1000-8-45

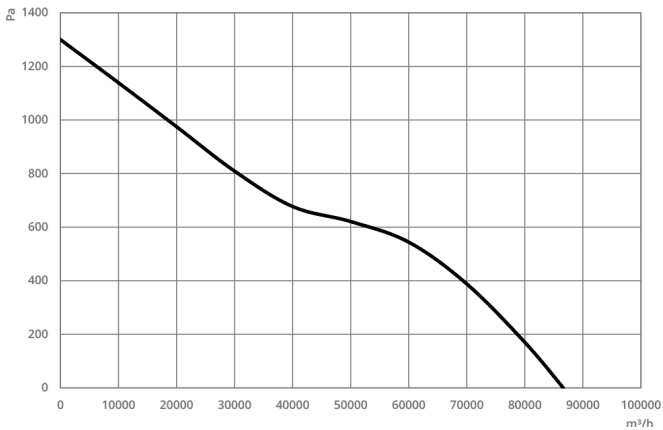

MA-HF 1120-8-40

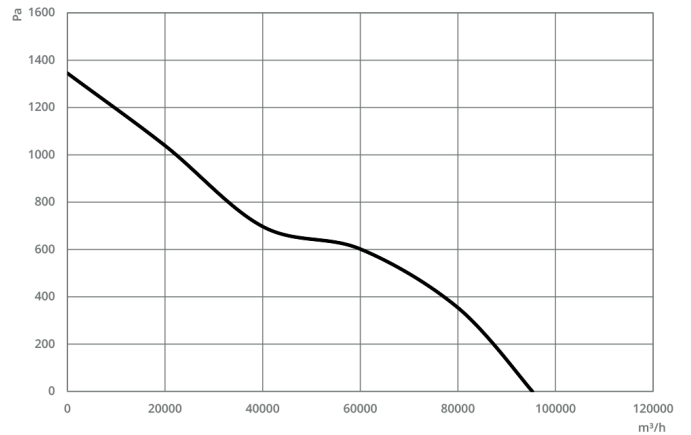

MA-HF 1120-8-45







Motor Insulation Class	Motor Protection Class	Body Material	Impeller Material	Working Temperature	Standards
F Class	IP55	Galvanized Sheet Metal	Aluminium	-20 - +50 °C	IEC-60335-2-80 ISO 1940-1

# MFA

## POULTRY FAN

MA-HF serie Axial box fans can be used in difficult montage systems with its multiple connection solutions. Having on-off switch and inbuilt sound attenuator.

## Technical Information

Model Type	Max m <sup>3</sup> /h	W	rpm d/d	Hz	Voltage	Sound dB
MFA 100	22500	370	610	50	380	73
MFA 140	44500	1100	439	50	380	73

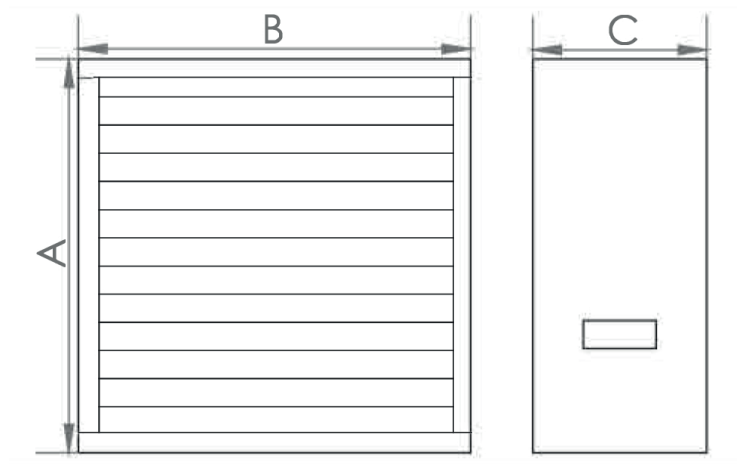

Model Type	A	B	C
MFA 100	960	960	400
MFA 140	1390	1390	400



Motor Insulation Class	Motor Protection Class	Body Material	Impeller Material	Working Temperature	Standards
F Class	IP55	Galvanized Sheet Metal	Aluminium	-20 - +50 °C	IEC-60335-2-80 ISO 1940-1

# MAP

## AXIAL PRESSURIZATION FANS

MAP serie Pressure Fans are highly used in staircases, elevator shafts and oanywhere need in high volume-low pressure systems.

## Technical Information

Model Type	Max m <sup>3</sup> /h	kW	rpm d/d	Hz	Voltage	Sound dB
MAP 400-5-25	2895	0,37	1450	50	380	66
MAP 450-5-25	4180	0,55	1456	50	380	69
MAP 500-5-25	5845	0,55	1453	50	380	72
MAP 560-5-25	8150	0,75	1466	50	380	75
MAP 630-5-30	13480	1,1	1465	50	380	80
MAP 710-5-30	19210	1,5	1472	50	380	83
MAP 800-5-30	25560	2,2	1459	50	380	85
MAP 800-5-35	30940	3	1463	50	380	89
MAP 900-5-35	39250	4	1471	50	380	90
MAP 900-5-40	44635	5,5	1472	50	380	93
MAP 1000-5-40	54570	7,5	1478	50	380	94
MAP 900-8-40	46200	11	1454	50	380	94
MAP 1000-8-40	62250	15	1456	50	380	97
MAP 1000-8-45	69070	18,5	1458	50	380	99
MAP 1120-8-40	86620	22	1471	50	380	100
MAP 1120-8-45	95270	30	1474	50	380	102

Technical Information

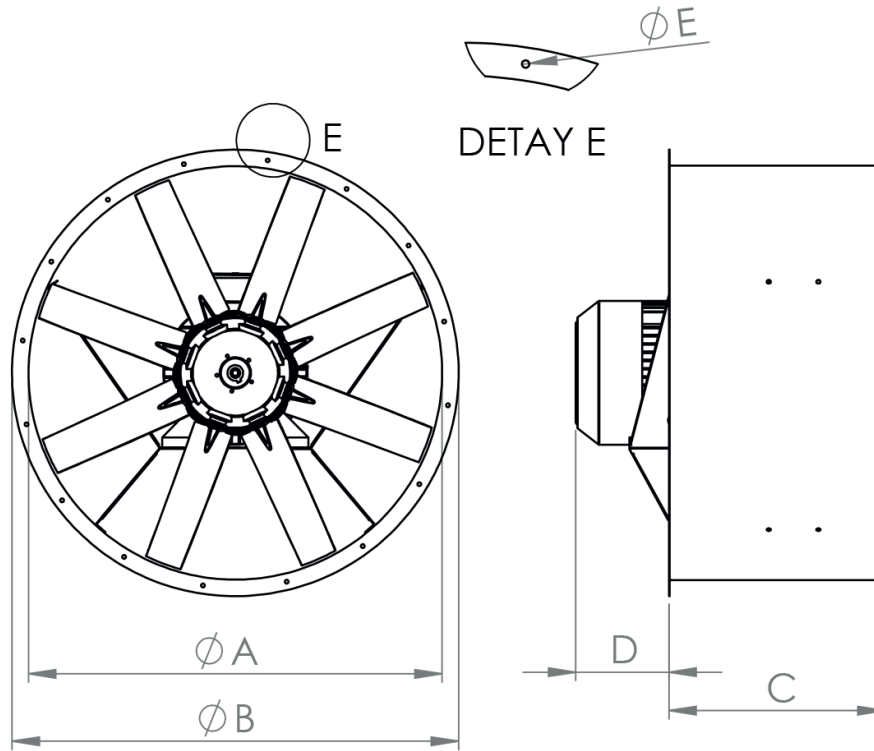

Model Type	A	B	C	D	E	N (Number of Holes)
MAP 400-5-25	400	480	320	30	11	8
MAP 450-5-25	450	530	320	50	11	8
MAP 500-5-25	500	580	320	70	11	8
MAP 560-5-25	560	640	320	60	11	12
MAP 630-5-30	630	710	420	45	11	12
MAP 710-5-30	710	790	420	25	11	12
MAP 800-5-30	800	880	420	50	11	16
MAP 800-5-35	800	880	420	50	11	16
MAP 900-5-35	900	980	520	0	11	16
MAP 900-5-40	900	980	520	35	11	16
MAP 1000-5-40	1000	1080	520	150	11	16
MAP 900-8-40	900	980	520	75	11	16
MAP 1000-8-40	1000	1080	520	180	11	16
MAP 1000-8-45	1000	1080	520	250	11	16
MAP 1120-8-40	1120	1200	520	250	11	16
MAP 1120-8-45	1120	1200	520	300	11	16

## Pressure Curves

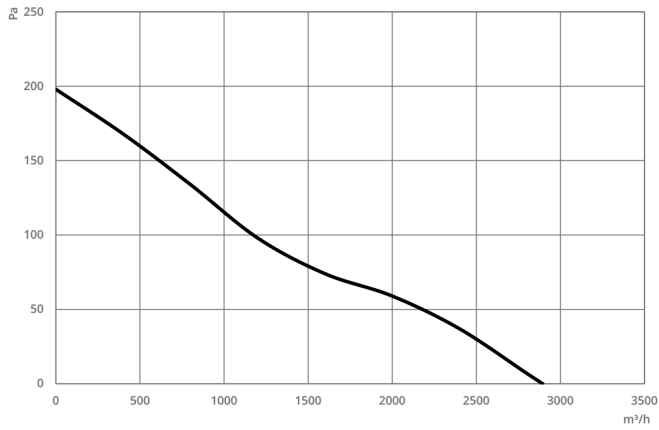

MAP 400-5-25

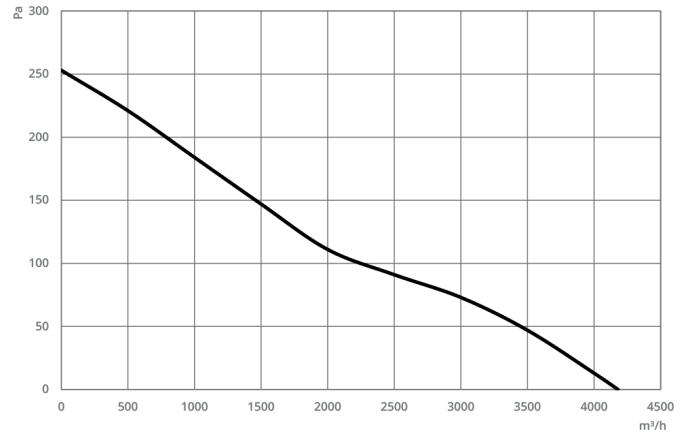

MAP 450-5-25

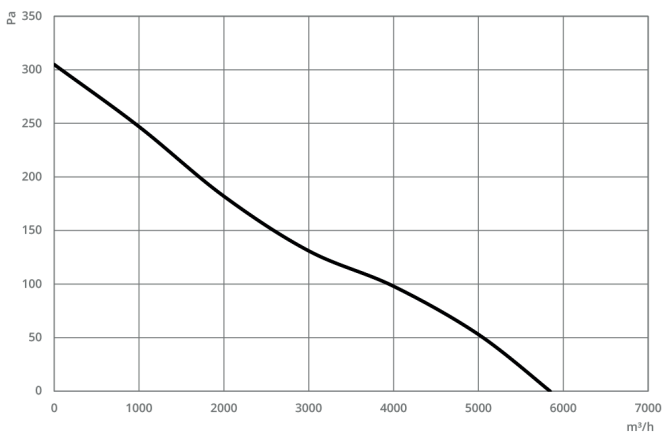

MAP 500-5-25

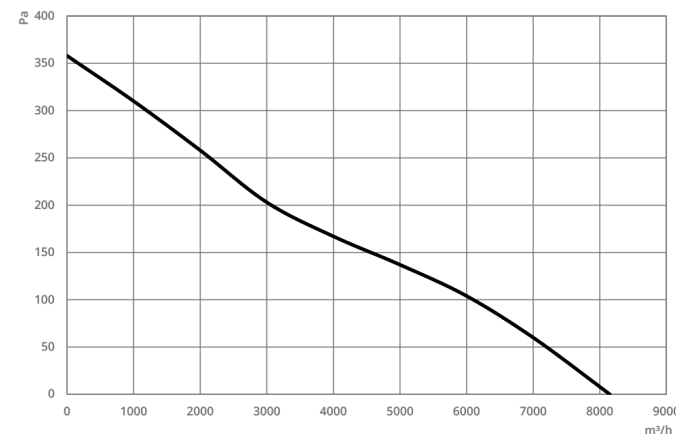

MAP 560-5-25

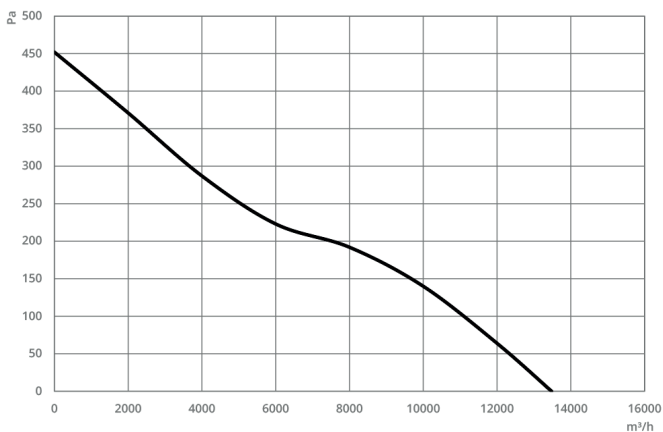

MAP 630-5-30

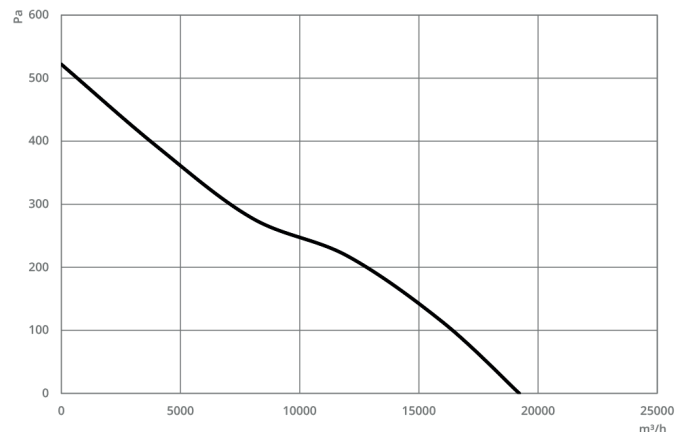

MAP 710-5-30

Pressure Curves

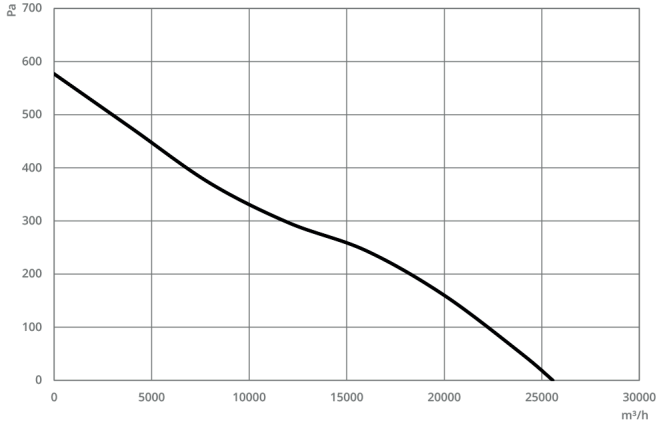

MAP 800-5-30

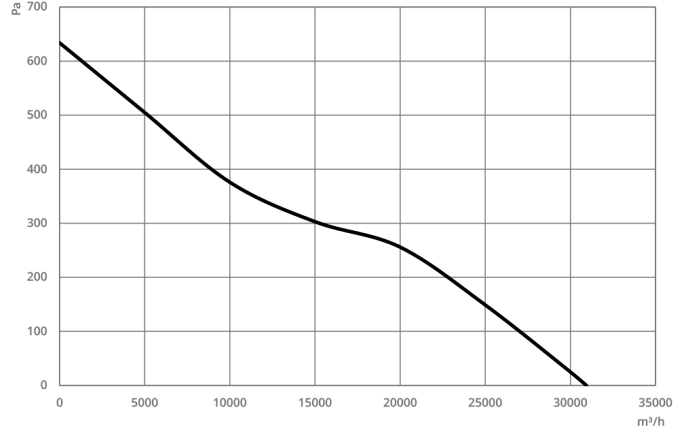

MAP 800-5-35

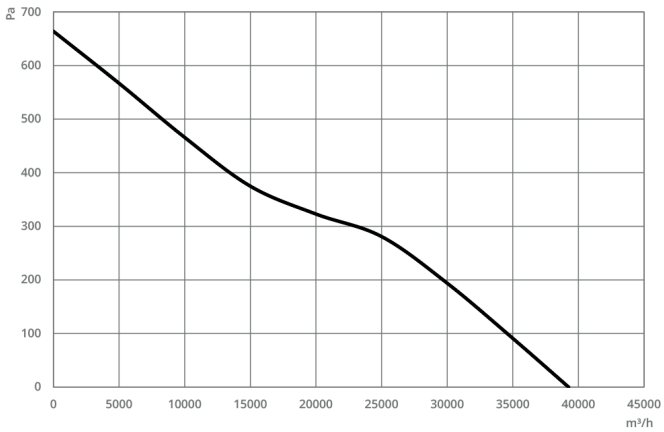

MAP 900-5-35

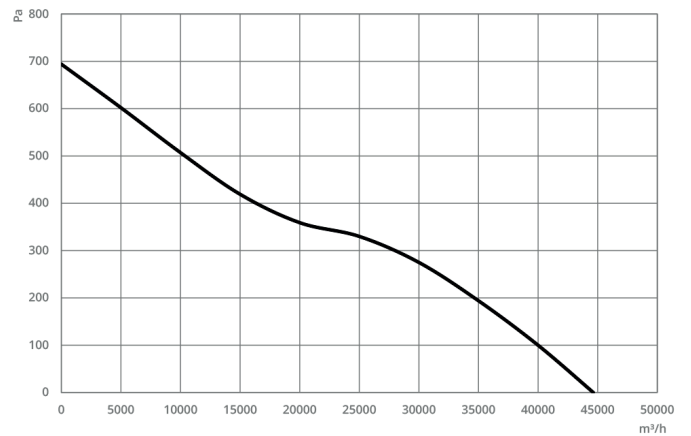

MAP 900-5-40

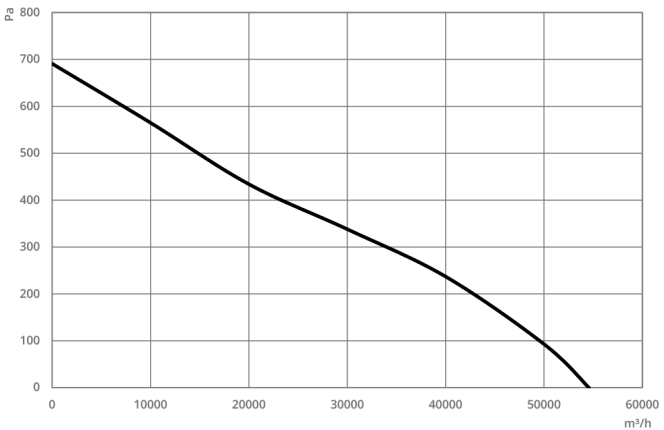

MAP 1000-5-40

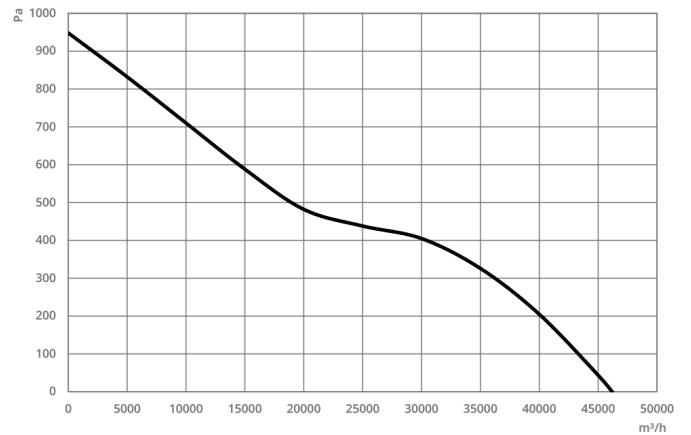

MAP 900-8-40







# MA-WFE MA-WFES

## INDUSTRIAL AXIAL FANS

It has direct coupled three-phase or single phase motor options. It has a 6-bladed, concave blade system. It is very easy to install on the wall and window.

**Insulation class B, protection class IP 44.**

## Technical Information

Model Type	Max m <sup>3</sup> /h	kW	rpm d/d	Hz	Voltage	KG
MA-WFE M-300	2000	90	1445	50	230	8
MA-WFE M-350	3250	160	1460	50	230	8,2
MA-WFE M-400	4500	185	1425	50	230	8,8
MA-WFE M-500	5500	230	1440	50	230	11
MA-WFE M-600	8000	235	1400	50	230	15,6
MA-WFE T-300	2000	130	1450	50	380	8
MA-WFE T-350	3250	135	1470	50	380	8,2
MA-WFE T-400	4500	150	1450	50	380	8,8
MA-WFE T-500	5500	160	1450	50	380	11
MA-WFE T-600	8000	170	1400	50	380	15,6

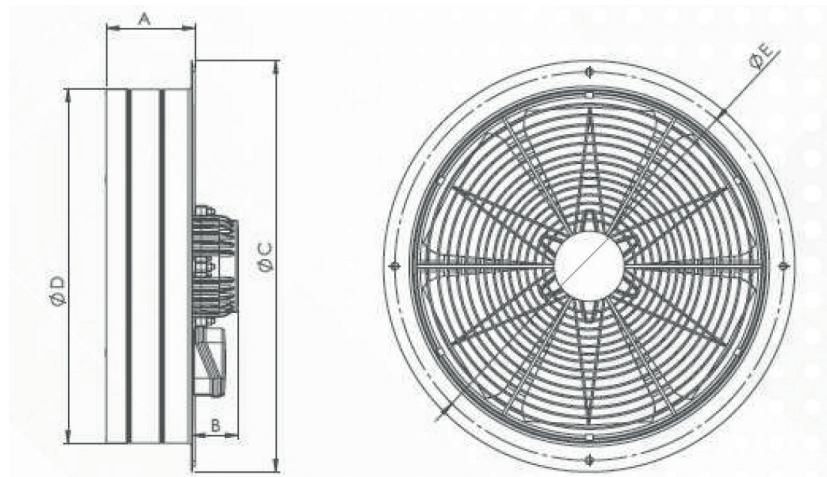

Model Type	A	B	C	D	E
MA-WFE M/T-300	114	61	390	325	360
MA-WFE M/T-350	114	61	435	374	405
MA-WFE M/T-450	114	61	485	427	455
MA-WFE M/T-500	125	61	590	518	560
MA-WFE M/T-600	130	160	674	610	645

Technical Information

Model Type	Max m <sup>3</sup> /h	kW	rpm d/d	Hz	Voltage	KG
MA-WFES M-300	2000	90	1445	50	230	7
MA-WFES M-350	3250	160	1460	50	230	8,2
MA-WFES M-400	4500	185	1425	50	230	9
MA-WFES M-500	5500	230	1440	50	230	11
MA-WFES M-600	8000	235	1400	50	230	15,6
MA-WFES T-300	2000	130	1450	50	380	7
MA-WFES T-350	3250	135	1470	50	380	8,2
MA-WFES T-400	4500	150	1450	50	380	9
MA-WFES T-500	5500	160	1450	50	380	11
MA-WFES T-600	8000	170	1400	50	380	15,6

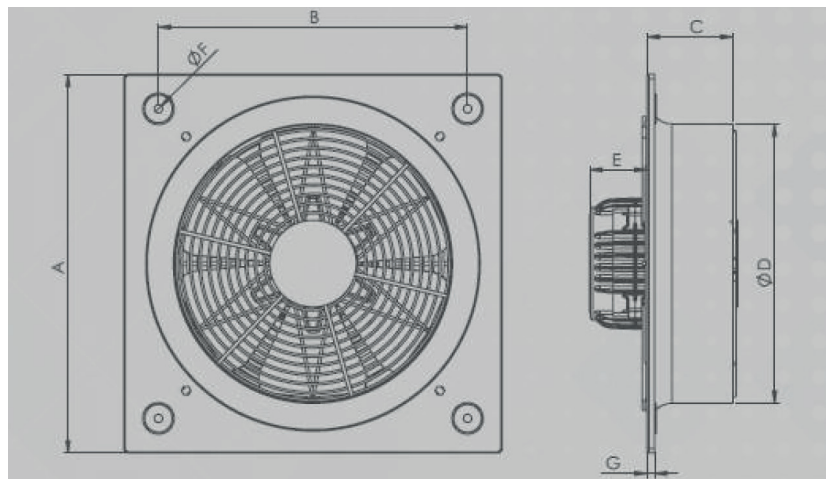

Model Type	A	B	C	D	E	F	G
MA-WFES M/T-300	412	336	80	307	80	8	10
MA-WFES M/T-350	465	390	90	365	80	8	10
MA-WFES M/T-450	500	420	100	403	80	8	10
MA-WFES M/T-500	630	561	110	513	90	8	10
MA-WFES M/T-600	700	631	145	612	135	8	10





Motor Insulation Class	Motor Protection Class	Body Material	Impeller Material	Working Temperature	Standards
F Class	IP55	Galvanized Sheet Metal	Aluminium	-20 - +50 °C	IEC-60335-2-80 ISO 1940-1

# MAP-BD

## BELT DRIVEN AXIAL FAN

MAP-BD serie Belt driven axial fans can be used in ventilation systems where the motor need to be out of the airflow.

## Technical Information

Model Type	Max m <sup>3</sup> /h	kW	rpm d/d	Hz	Voltage	Sound dB
MAP-BD 400-5-25	2895	0,37	1450	50	380	66
MAP-BD 450-5-25	4180	0,55	1456	50	380	69
MAP-BD 500-5-25	5845	0,55	1453	50	380	72
MAP-BD 560-5-25	8150	0,75	1466	50	380	75
MAP-BD 630-5-30	13480	1,1	1465	50	380	80
MAP-BD 710-5-30	19210	1,5	1472	50	380	83
MAP-BD 800-5-30	25560	2,2	1459	50	380	85
MAP-BD 800-5-35	30940	3	1463	50	380	89
MAP-BD 900-5-35	39250	4	1471	50	380	90
MAP-BD 900-5-40	44635	5,5	1472	50	380	93
MAP-BD 1000-5-40	54570	7,5	1478	50	380	94
MAP-BD 900-8-40	46200	11	1454	50	380	94
MAP-BD 1000-8-40	62250	15	1456	50	380	97
MAP-BD 1000-8-45	69070	18,5	1458	50	380	99
MAP-BD 1120-8-40	86620	22	1471	50	380	100
MAP-BD 1120-8-45	95270	30	1474	50	380	102

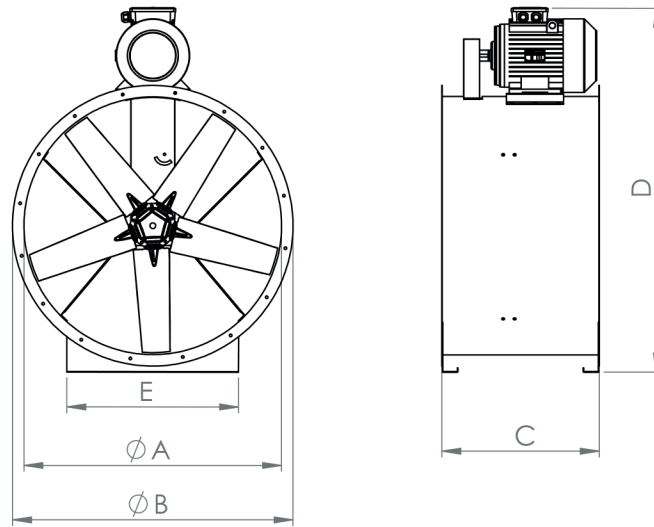

Model Type	A	B	C	D	E
MAP-BD 400	400	480	380	660	300
MAP-BD 450	450	530	400	720	330
MAP-BD 500	500	580	400	770	360
MAP-BD 560	560	640	430	840	400
MAP-BD 630	630	710	500	925	440
MAP-BD 710	710	790	500	1005	480
MAP-BD 800	800	880	500	1110	520
MAP-BD 900	900	980	740	1360	560
MAP-BD 1000	1000	1080	740	1470	600

Model Type	A	B	C	D	E
DAXI 1000	1000	1080	836	1195	2000
DAXI 1120	1120	1200	956	1315	2000

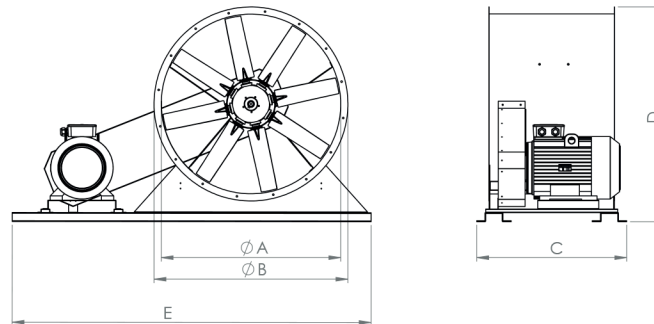

## Pressure Curves

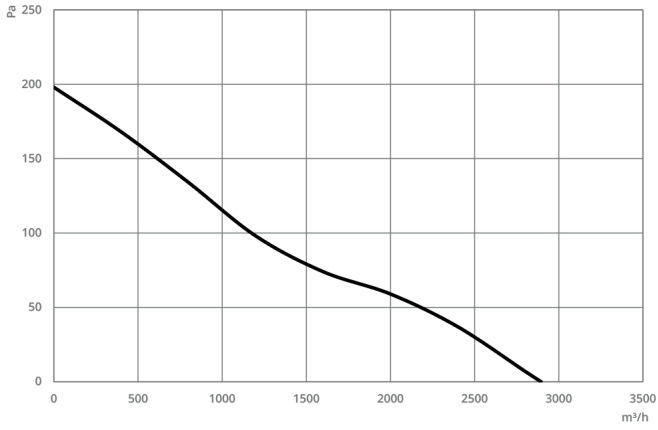

MAP-BD 400-5-25

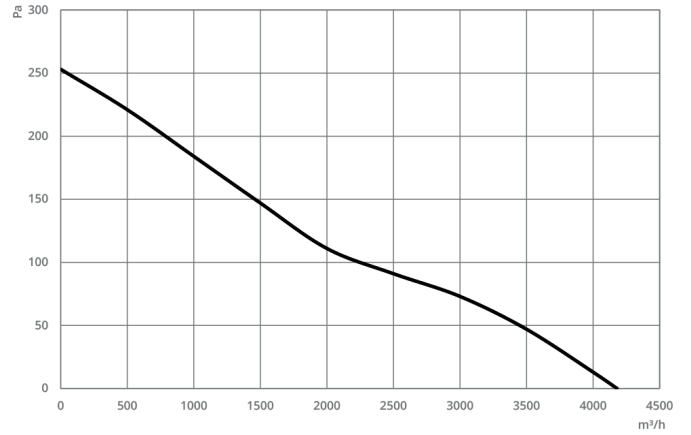

MAP-BD 450-5-25

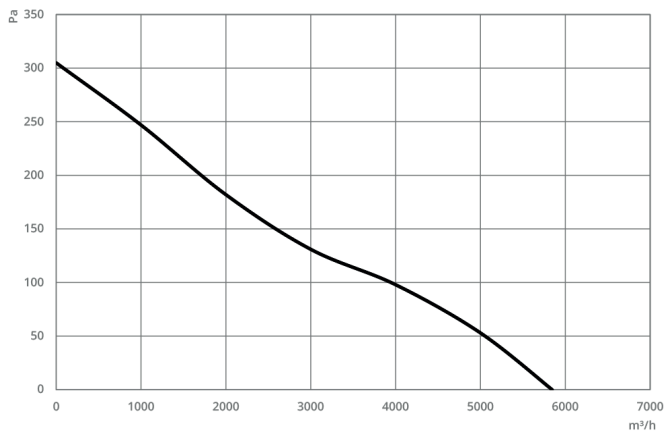

MAP-BD 500-5-25

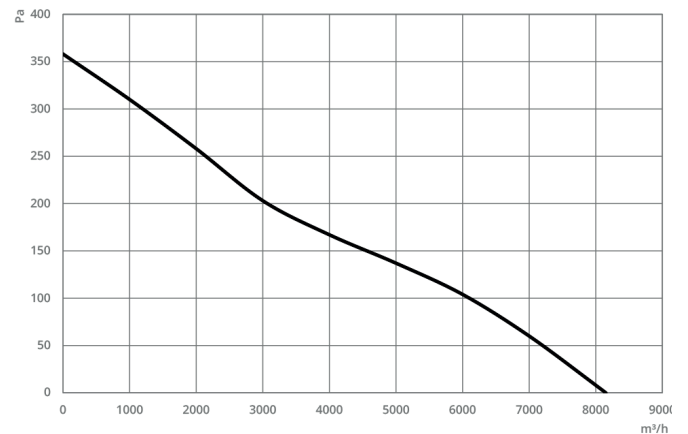

MAP-BD 560-5-25

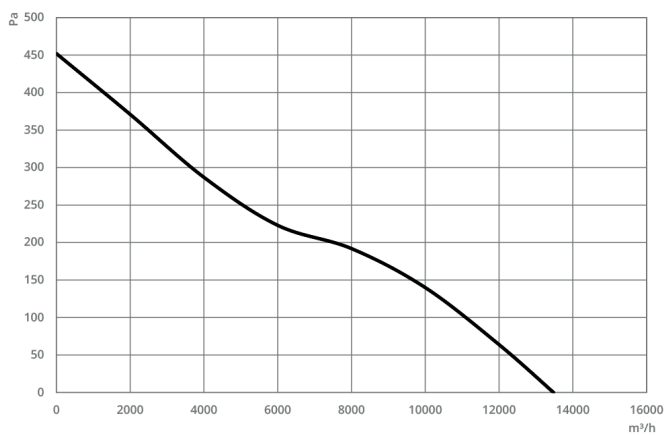

MAP-BD 630-5-30

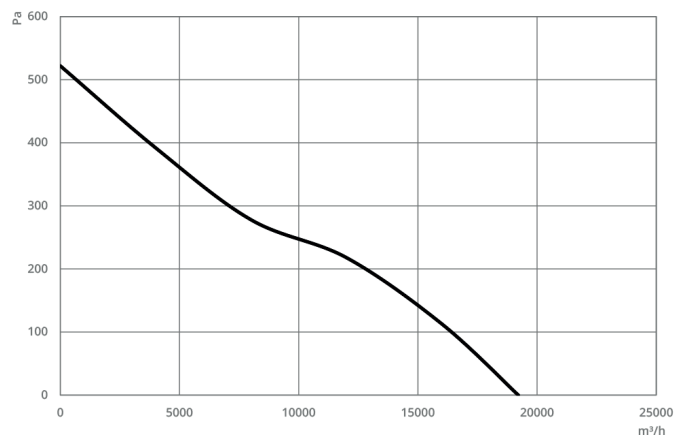

MAP-BD 710-5-30



Pressure Curves

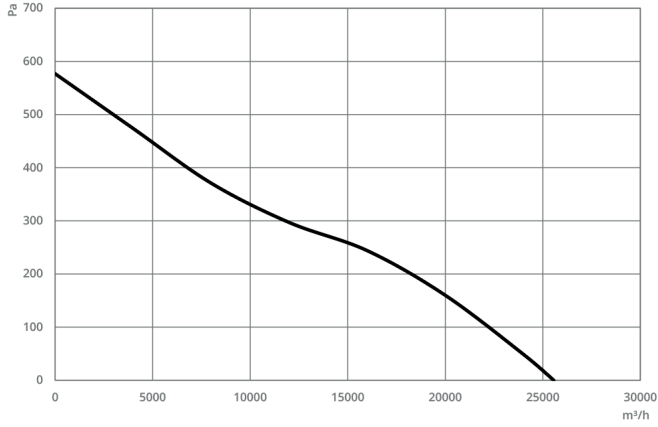

MAP-BD 800-5-30

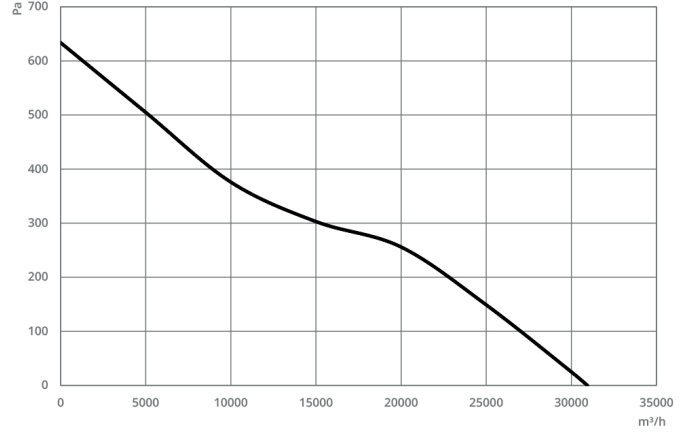

MAP-BD 800-5-35

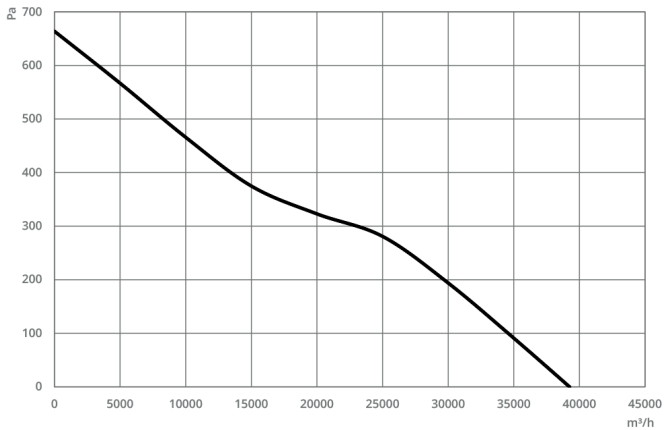

MAP-BD 900-5-35

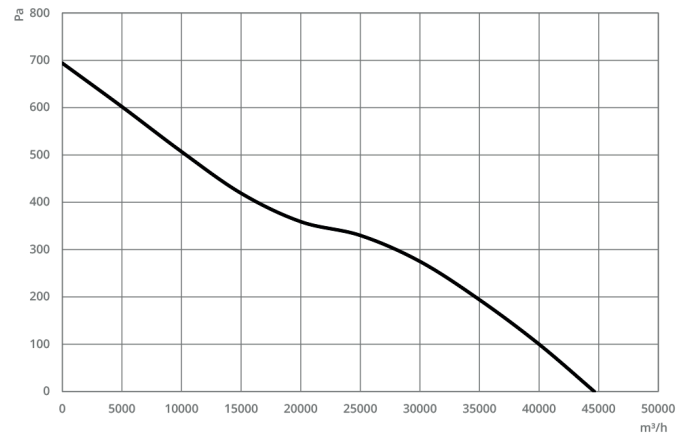

MAP-BD 900-5-40

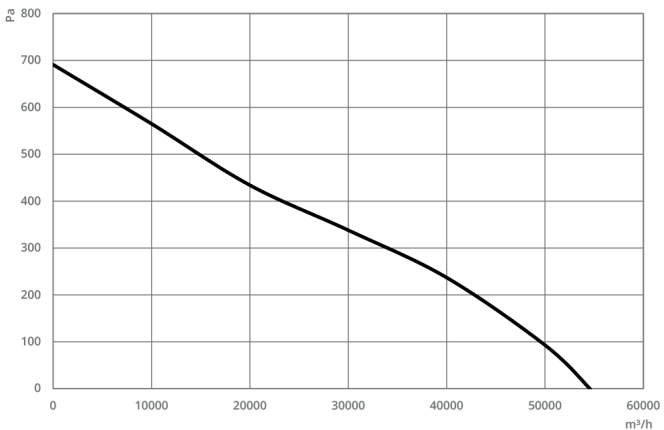

MAP-BD 1000-5-40

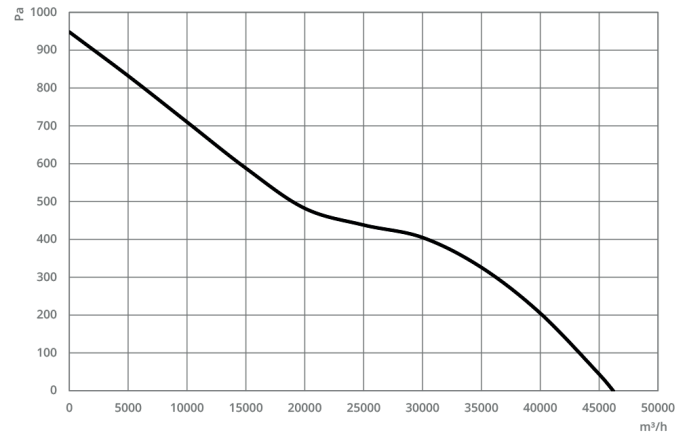

MAP-BD 900-8-40

## Pressure Curves

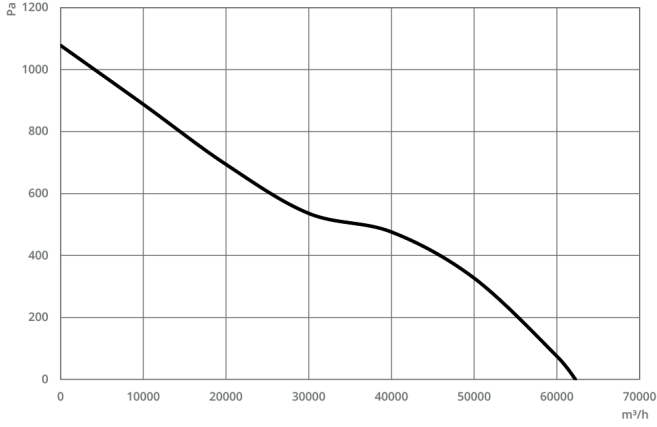

MAP-BD 1000-8-40

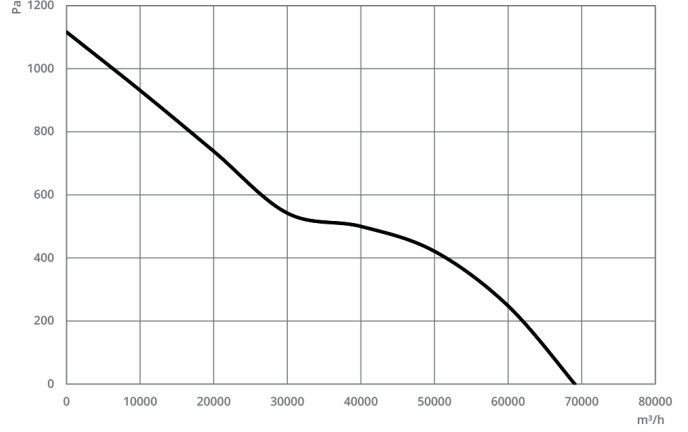

MAP-BD 1000-8-45

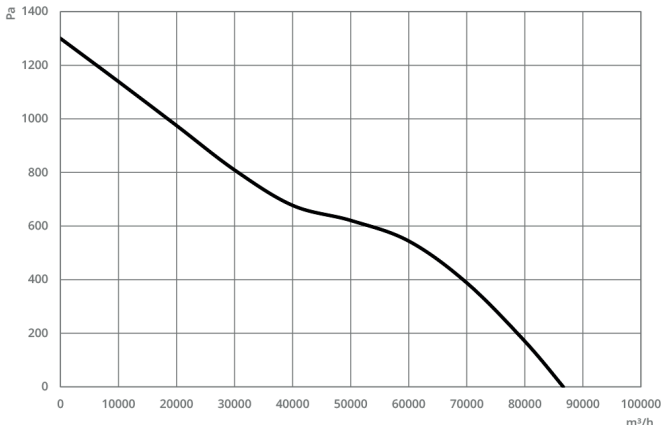

MAP-BD 1120-8-40

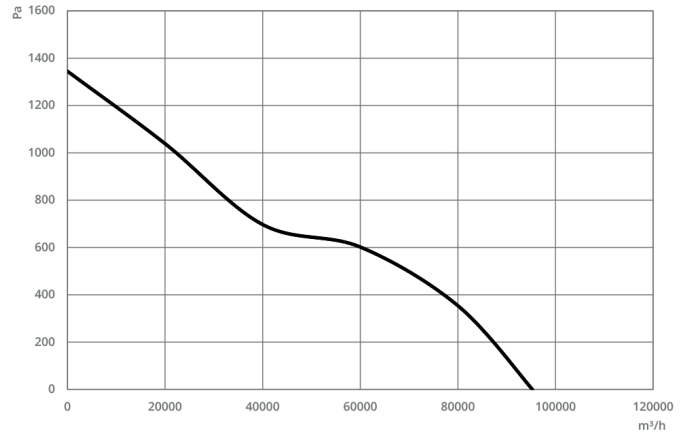

MAP-BD 1120-8-45



Motor Insulation Class	Motor Protection Class	Body Material	Impeller Material	Working Temperature	Standards
F Class	IP55	Galvanized Sheet Metal	Galvanized Sheet Metal	-20 - +50 °C	IEC-60335-2-80 ISO 1940-1

# MAW

## WALL MOUNTED AXIAL FAN

MAW Serie Axial fans can meet low volume requirements. Suitable for walls and windows. Low noise level and efficiency power usage makes it ideal for commercial and residential purposes.

## Technical Information

Model Type	Max m <sup>3</sup> /h	W	rpm d/d	Hz	Voltage	Sound dB
MAW 200	680	70	2650	50	230	50
MAW 250	1500	100	2700	50	230	52
MAW 300	2025	163	2550	50	230	54
MAW 350	3110	240	2250	50	230	58

Values are for 0 Pa.

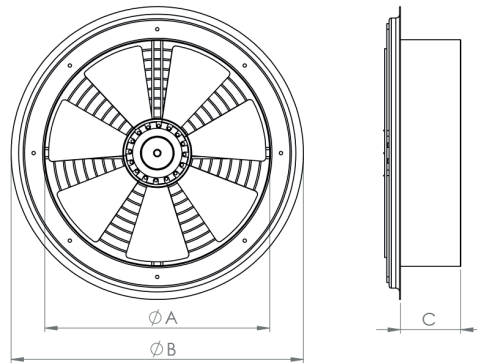

Model Type	A	B	C
MAW 200	197	290	70
MAW 250	247	340	70
MAW 300	297	390	80
MAW 350	347	440	80



Motor Insulation Class	Motor Protection Class	Body Material	Impeller Material	Working Temperature	Standards
F Class	IP55	Galvanized Sheet Metal	Galvanized Sheet Metal	-20 - +50 °C	IEC-60335-2-80 ISO 1940-1

## MAW-S

### WALL MOUNTED AXIAL FAN WITH SQUARE BODY

MAW-S Serie Axial fans can meet low volume requirements. Suitable for walls and windows. Low noise level and efficiency power usage makes it ideal for commercial and residential purposes. Square body make easy wall installation.

## Technical Information

Model Type	Max m <sup>3</sup> /h	W	rpm d/d	Hz	Voltage	Sound dB
MAW-S 200	680	70	2650	50	230	50
MAW-S 250	1500	100	2700	50	230	52
MAW-S 300	2025	163	2550	50	230	54
MAW-S 350	3110	240	2250	50	230	58

Values are for 0 Pa.

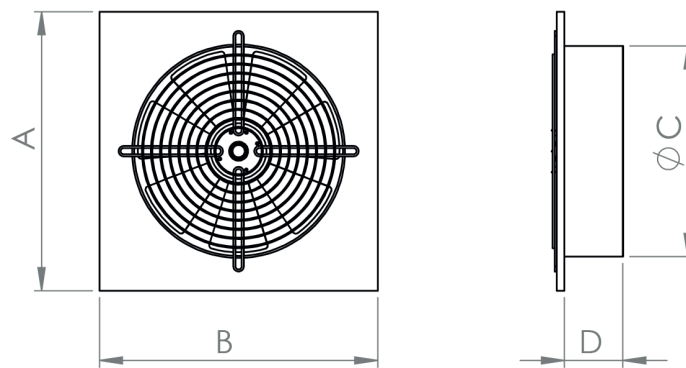

Model Type	A	B	C	D
MAW-S 200	250	250	197	85
MAW-S 250	300	300	247	85
MAW-S 300	350	350	297	85
MAW-S 350	400	400	347	85