



KITCHEN & EXHAUST UNITS



Kitchen & Exhaust Units Models

MKE-C

MKE-CE

MKE-EP

MKE-KC

MKE-KCA





MKE-C

EXHAUST FANS

MKE-C Serie Exhaust Fans offer you practical solutions especially in industrial kitchen applications.

Technical Information

Model Type	Max m ³ /h	Max Pa.	m/sn	kW	rpm d/d	A	Hz	Voltage	Sound dB	Max. De-gree	Kg. Max.
MKE-C 355/4K a	2200	290	10	0,37	1450	1,2	50	380	72	60	92
MKE-C 355/4K b	2400	330	10	0,55	1450	1,6	50	380	80	60	95
MKE-C 400/4K	3200	440	11	0,75	1450	2,1	50	380	83	60	98
MKE-C 450/4K a	5000	450	13	0,75	1450	2,7	50	380	84	60	103
MKE-C 450/4K b	5750	570	13,5	1,1	1450	3,6	50	380	87	60	110
MKE-C 500/4K	7500	670	15	1,5	1450	5,3	50	380	90	60	120
MKE-C 560/4K a	10000	720	16	2,2	1450	6,6	50	380	91	60	156
MKE-C 560/4K b	12000	750	16,5	3	1450	8,7	50	380	93	60	162
MKE-C 630/4K	16000	1000	18	4	1450	11,8	50	380	95	60	246
MKE-C 710/4K a	18500	1000	19	5,5	1450	15,8	50	380	97	60	330
MKE-C 710/4K b	20000	1000	19,5	7,5	1450	22,5	50	380	99	60	340
MKE-C 800/4K a	25000	1000	22	11	1450	30,5	50	380	101	60	530
MKE-C 800/4K b	30000	1000	22	15	1450	37	50	380	103	60	540
MKE-C 900/4K	43000	1800	25	22	1450	39	50	380	110	60	670
MKE-C 1000/4K	58000	2500	30	30	1450	5	50	380	125	60	752

Technical Information

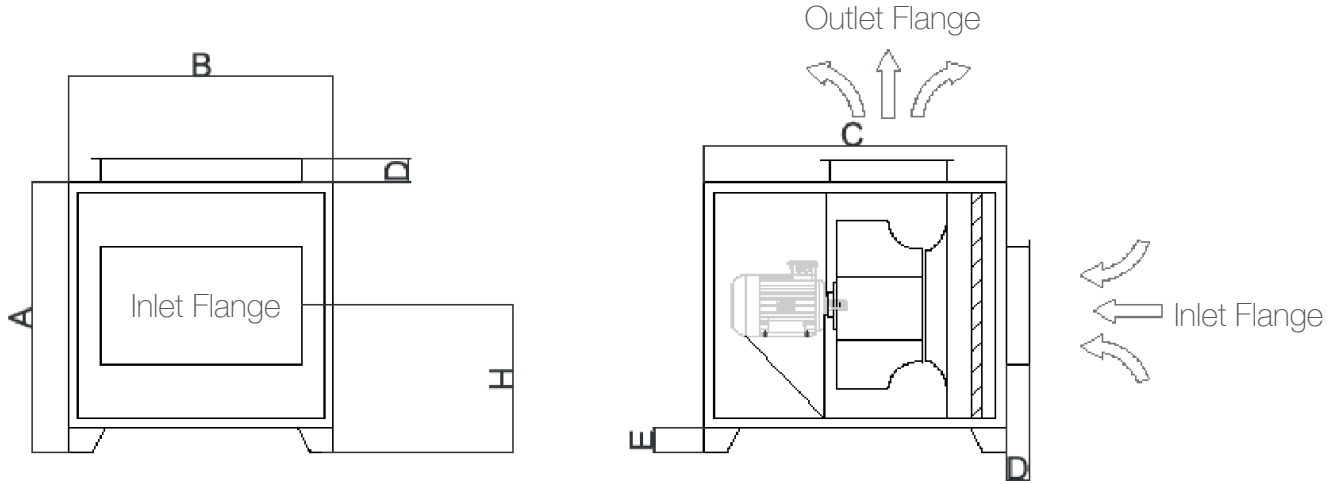

Model Type	A	B	C	D	E	H	INLET & OUTLET DIMENSION
MKE-C 355	765	665	740	100	100	433	400 x 200
MKE-C 400	810	710	820	100	100	455	500 x 250
MKE-C 450	855	755	840	100	100	477	500 x 250
MKE-C 500	855	755	840	100	100	477	600 x 350
MKE-C 560	965	865	960	100	100	533	600 x 350
MKE-C 630	1090	990	1040	100	100	595	700 x 400
MKE-C 710	1140	1040	1220	100	100	620	800 x 500

DIRECTION CHART

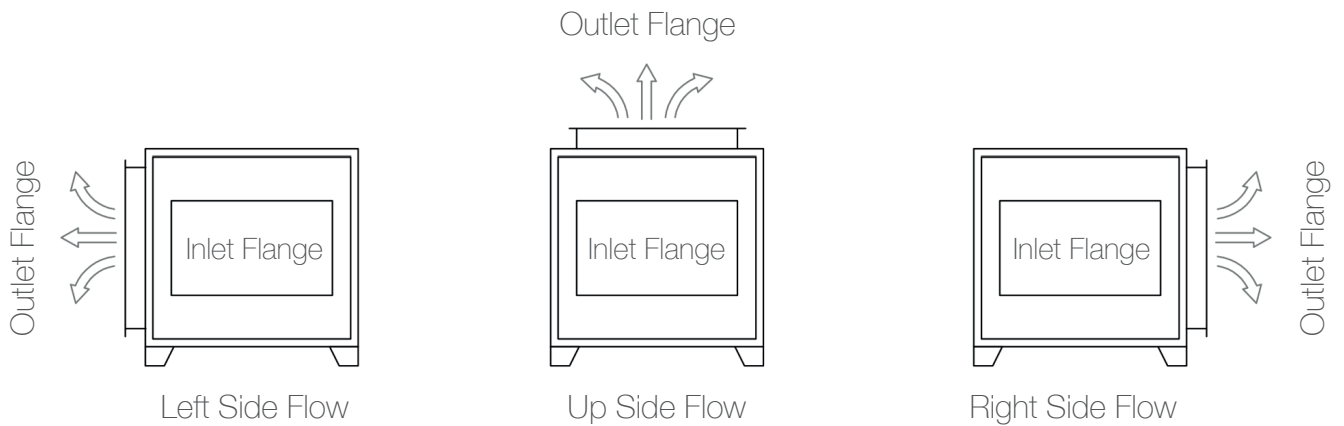

Pressure Curves

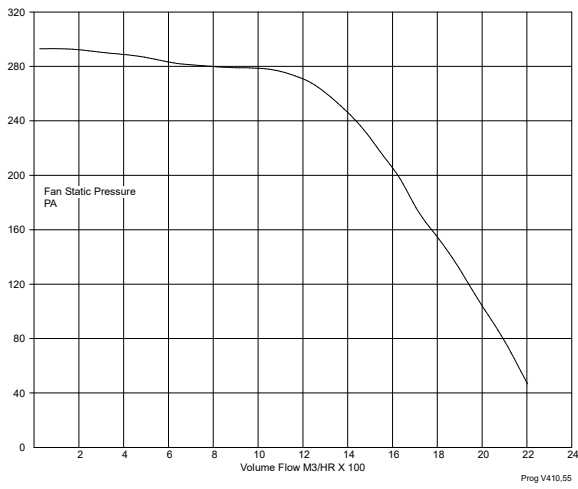

MKE-C 355/4K A

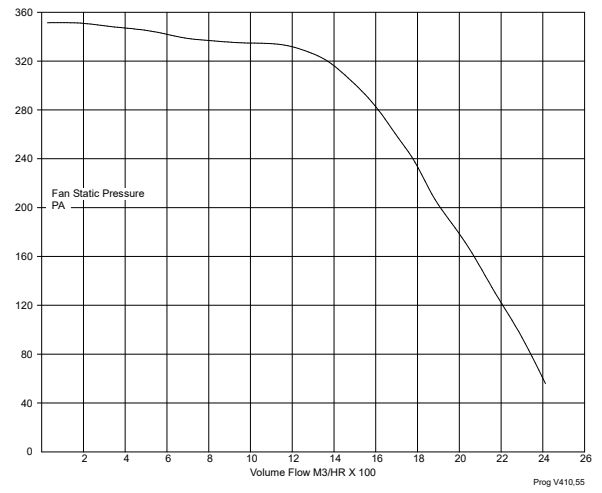

MKE-C 355/4K B

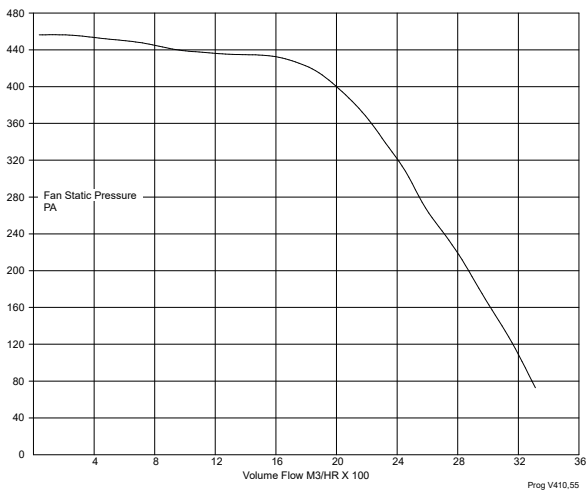

MKE-C 400/4K

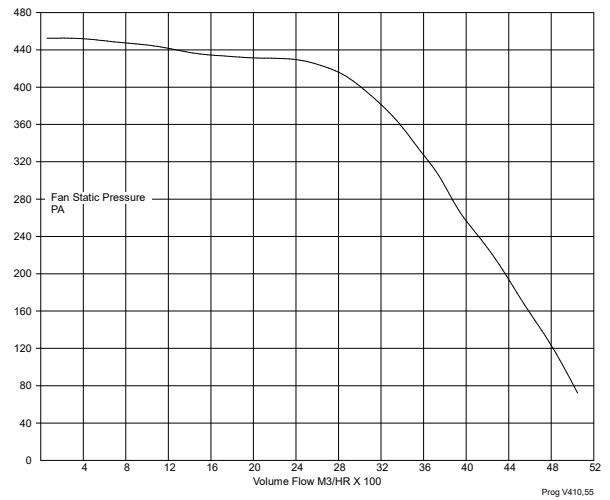

MKE-C 450/4K A

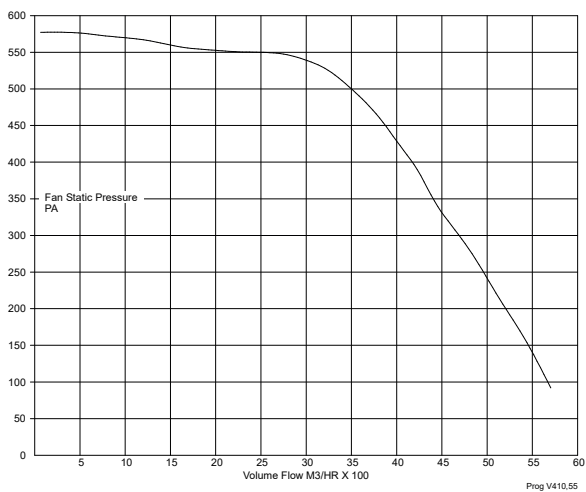

MKE-C 450/4K B

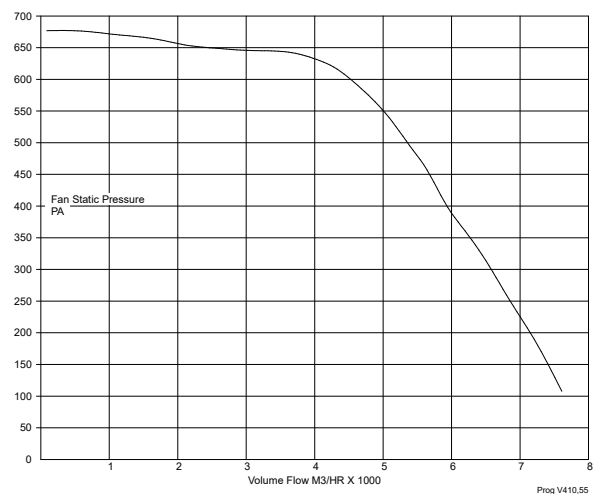

MKE-C 500/4K

Pressure Curves

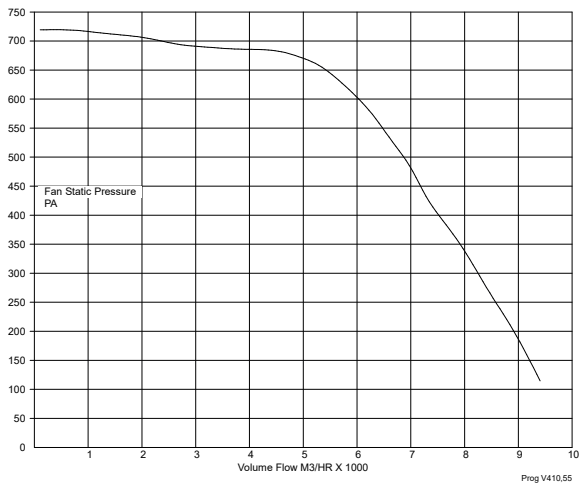

MKE-C 560/4K A

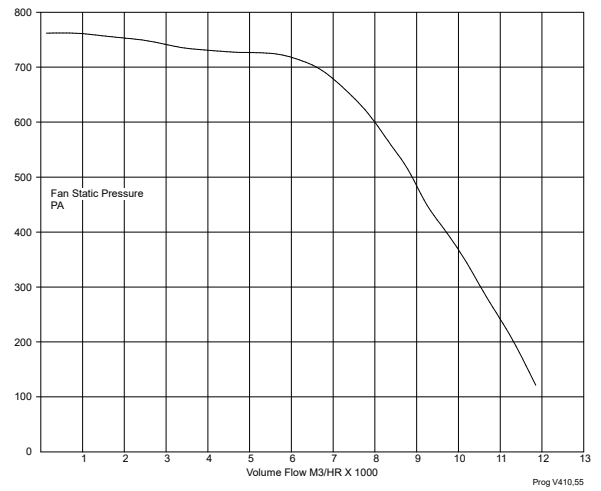

MKE-C 560/4K B

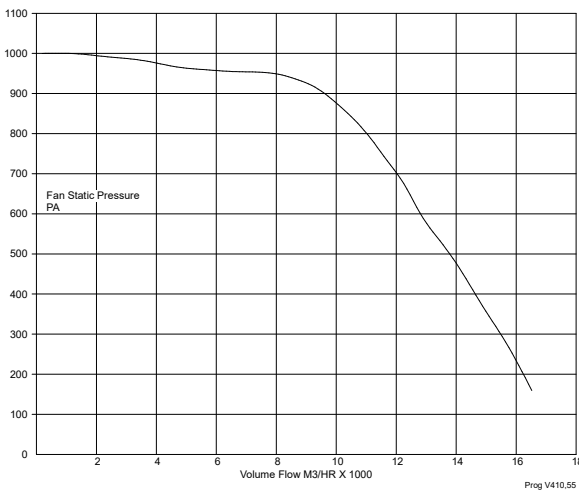

MKE-C 630/4K

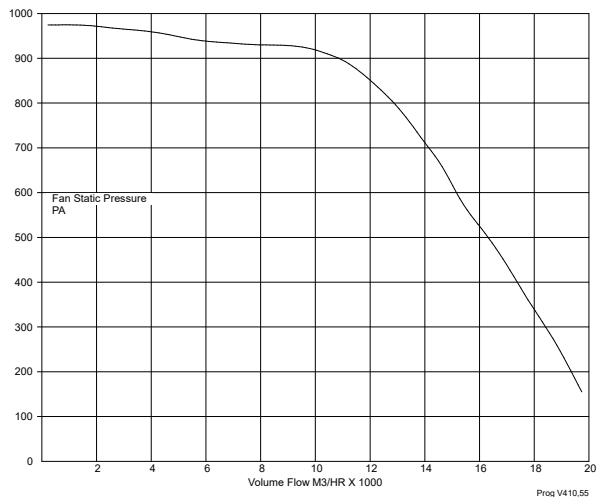

MKE-C 710/4K A

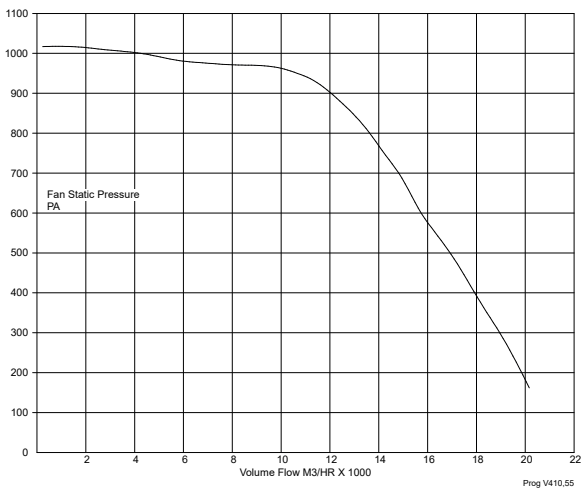

MKE-C 710/4K B

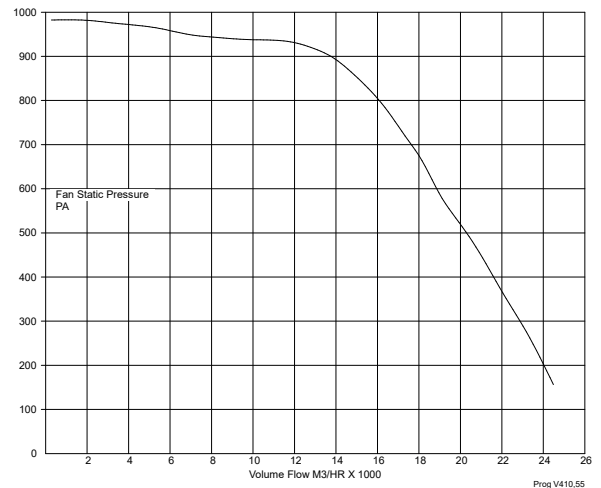

MKE-C 800/4K A

Pressure Curves

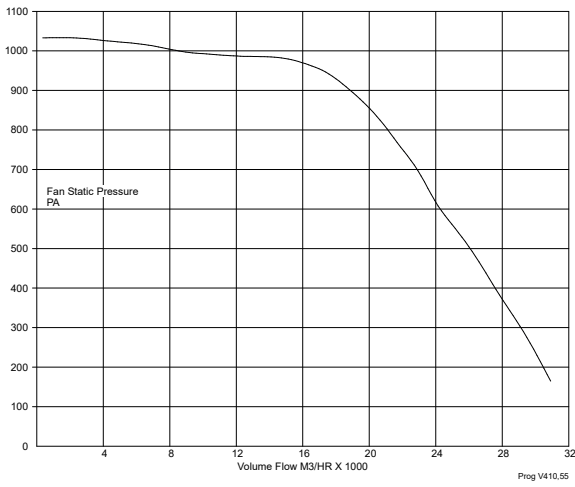

MKE-C 800/4K B

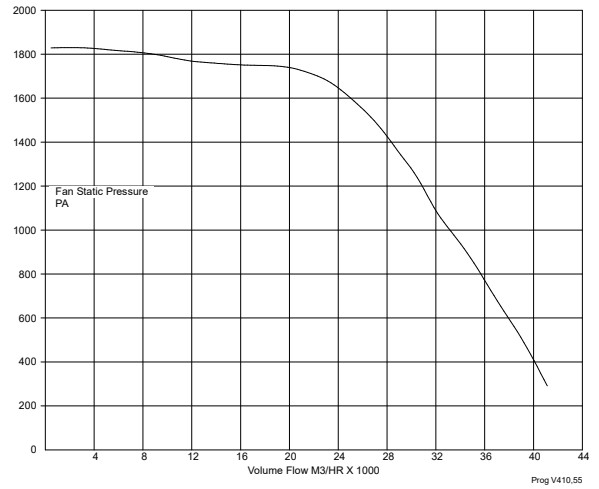

MKE-C 900/4K

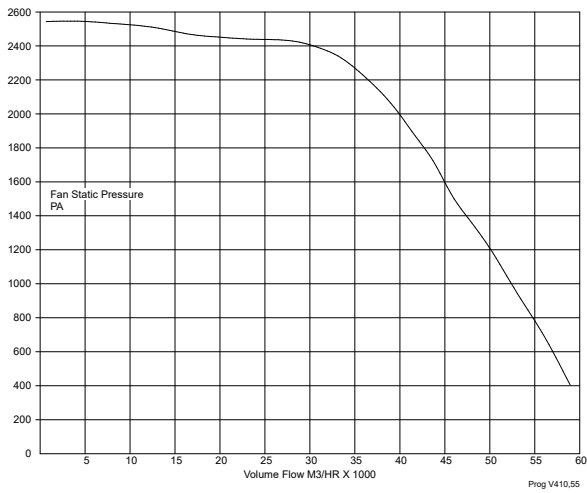

MKE-C 1000/4K

CE



MKE-CE

KITCHEN EXHAUST FAN-ECO

MKE-CE Serie Kitchen Exhaust Fans is suitable for more ergonomic solutions especially for industrial kitchen ventilation needs.

Technical Information

Model Type	Max m ³ /h	Max Pa.	m/sn	kW	rpm d/d	A	Hz	Voltage	Sound dB	Max. Degree
MKE-CE 400/4K	3200	440	11	0,75	1450	2,1	50	380	83	60
MKE-CE 450/4K a	5000	450	13	0,75	1450	2,7	50	380	84	60
MKE-CE 450/4K b	5750	570	13,5	1,1	1450	3,6	50	380	87	60
MKE-CE 500/4K	7500	670	15	1,5	1450	5,3	50	380	90	60
MKE-CE 560/4K a	10000	720	16	2,2	1450	6,6	50	380	91	60
MKE-CE 560/4K b	12000	750	16,5	3	1450	8,7	50	380	93	60
MKE-CE 630/4K	16000	1000	18	4	1450	11,8	50	380	95	60
MKE-CE 710/4K a	18500	1000	19	5,5	1450	15,8	50	380	97	60
MKE-CE 710/4K b	20000	1000	19,5	7,5	1450	22,5	50	380	99	60

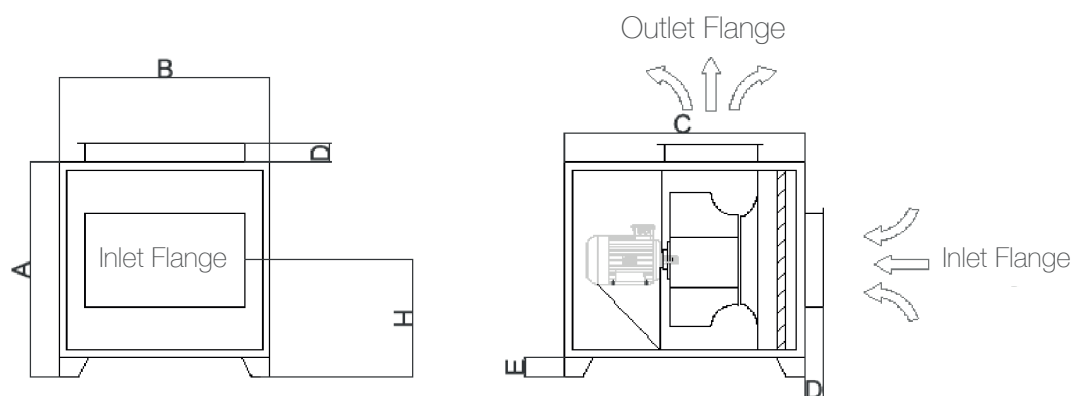

Model Type	A	B	C	D	E	H	INLET & OUTLET DIMENSION
MKE-CE 400	870	815	855	70	120	495	500 X 500 & 600 X 350
MKE-CE 450	870	815	855	70	120	495	500 X 500 & 600 X 350
MKE-CE 500	870	815	855	70	120	495	500 X 500 & 600 X 350
MKE-CE 560	870	815	855	70	120	495	500 X 500 & 600 X 350
MKE-CE 630	1070	1015	975	70	120	595	500 X 500 & 600 X 350
MKE-CE 710	1070	1015	975	70	120	595	700 X 700 & 800 X 350

DIRECTION CHART

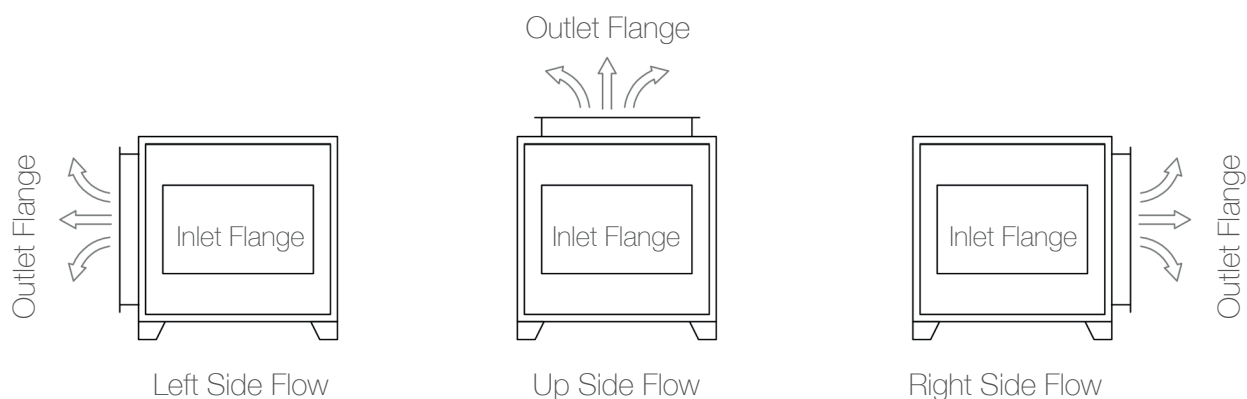

Pressure Curves

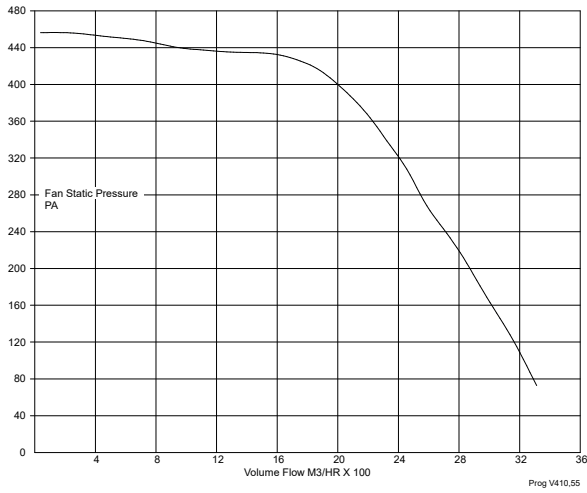

MKE-CE 400/4K

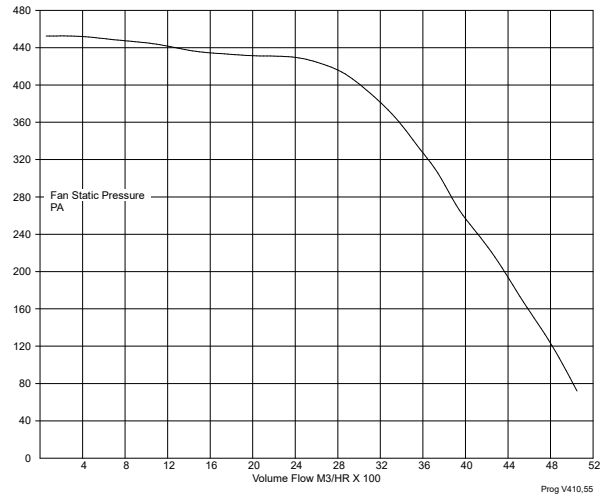

MKE-CE 450/4K A

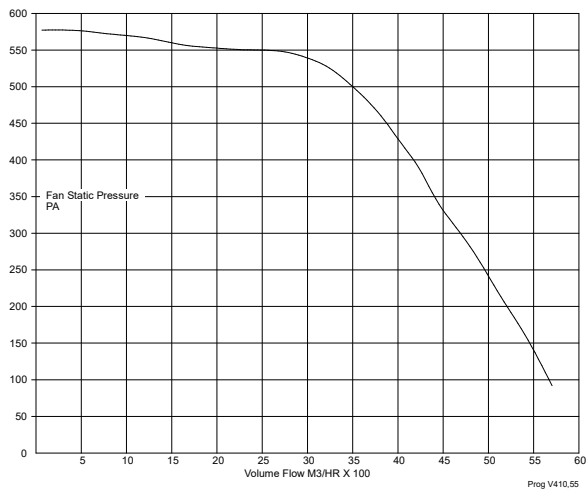

MKE-CE 450/4K B

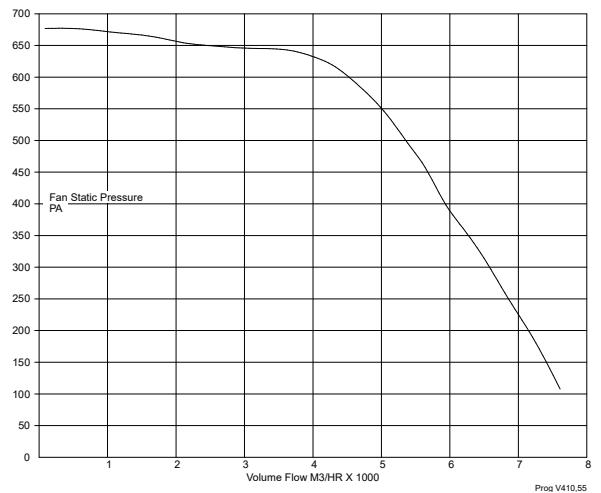

MKE-CE 500/4K

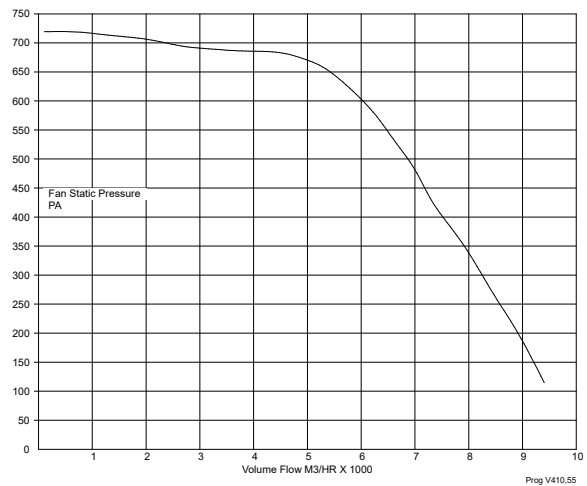

MKE-CE 560/4K A

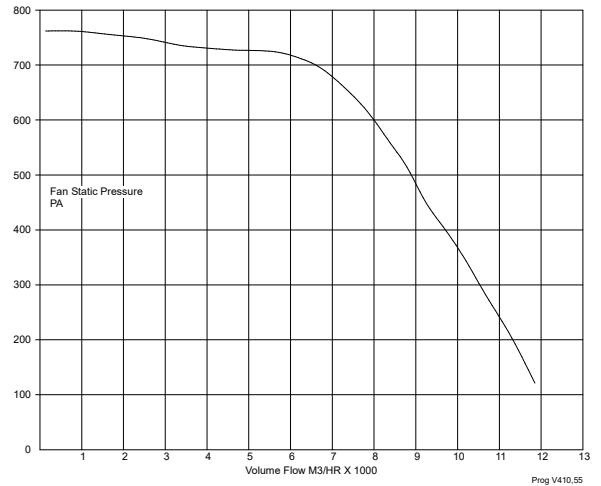

MKE-CE 560/4K B

Pressure Curves

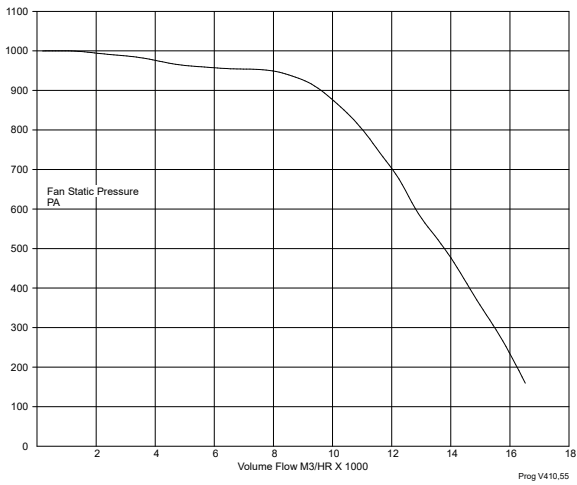

MKE-CE 630/4K

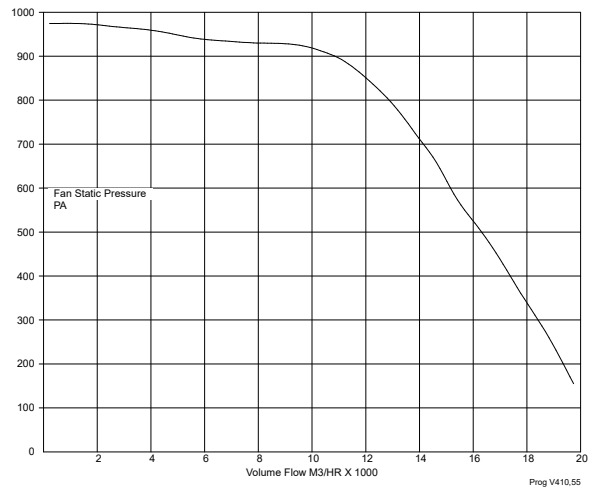

MKE-CE 710/4K A

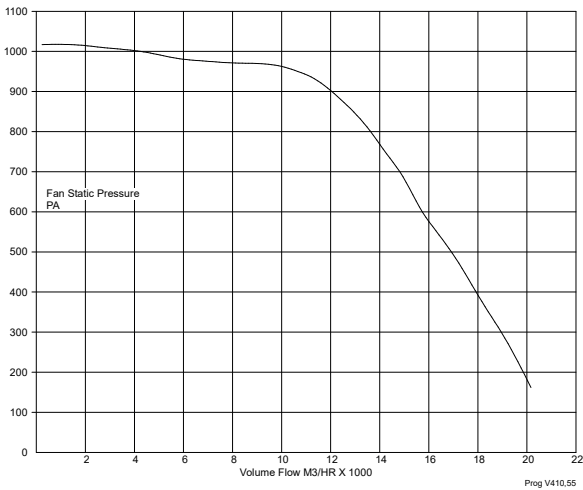

MKE-CE 710/4K B



MKE-EP

KITCHEN EXHAUST FAN-ECO PLUS

MKE-EP Serie Exhaust Fans is designed and developed for industrial kitchen fan solutions. Compact design, easy to install and maintenance.

Technical Information

Model Type	Max m ³ /h	Max Pa.	m/sn	kW	rpm d/d	A	Hz	Voltage	Sound dB	Max. Degree
MKE-EP 400/4K	3200	440	11	0,75	1450	2,1	50	380	83	60
MKE-EP 450/4K a	5000	450	13	0,75	1450	2,7	50	380	84	60
MKE-EP 450/4K b	5750	570	13,5	1,1	1450	3,6	50	380	87	60
MKE-EP 500/4K	7500	670	15	1,5	1450	5,3	50	380	90	60
MKE-EP 560/4K a	10000	720	16	2,2	1450	6,6	50	380	91	60
MKE-EP 560/4K b	12000	750	16,5	3	1450	8,7	50	380	93	60
MKE-EP 630/4K	16000	1000	18	4	1450	11,8	50	380	95	60
MKE-EP 710/4K a	18500	1000	19	5,5	1450	15,8	50	380	97	60
MKE-EP 710/4K b	20000	1000	19,5	7,5	1450	22,5	50	380	99	60

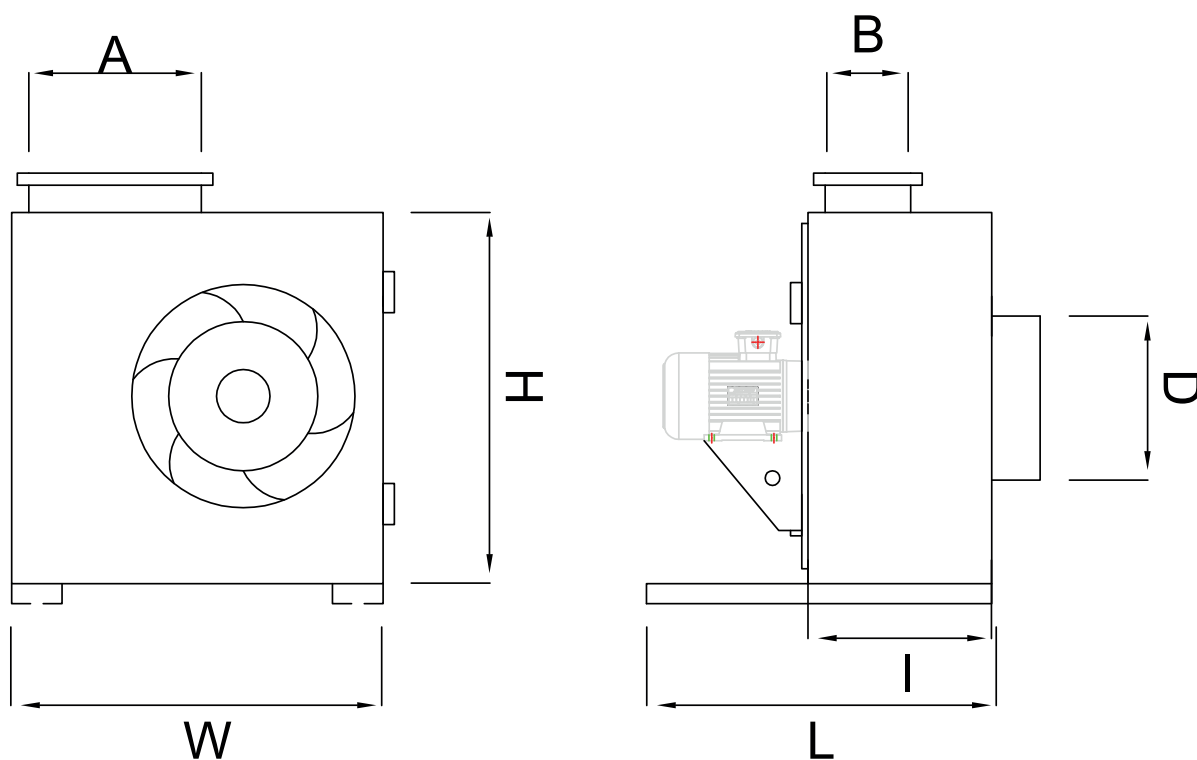

Model Type	W	H	L	I	AXB	QD	KG
MKE-EP 400	650	650	570	298	350 x 140	400	45
MKE-EP 450	700	700	600	310	380 x 150	450	70
MKE-EP 500	800	800	660	343	440 x 170	500	85
MKE-EP 560	900	900	777	400	490 x 200	560	105
MKE-EP 630	1000	1000	860	415	540 x 230	630	160
MKE-EP 710	1100	1100	980	467	590 x 260	710	203

Pressure Curves

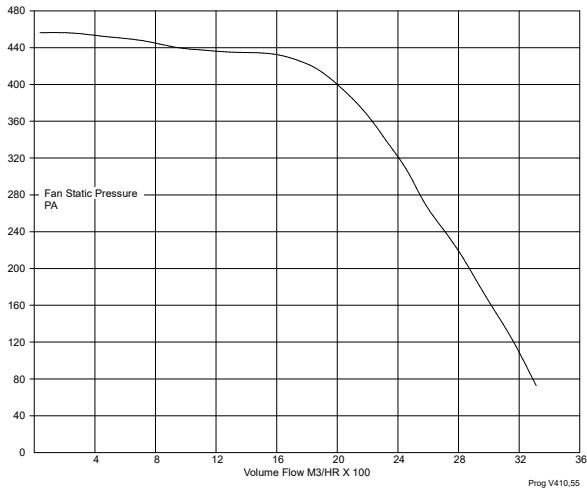

MKE-EP 400/4K

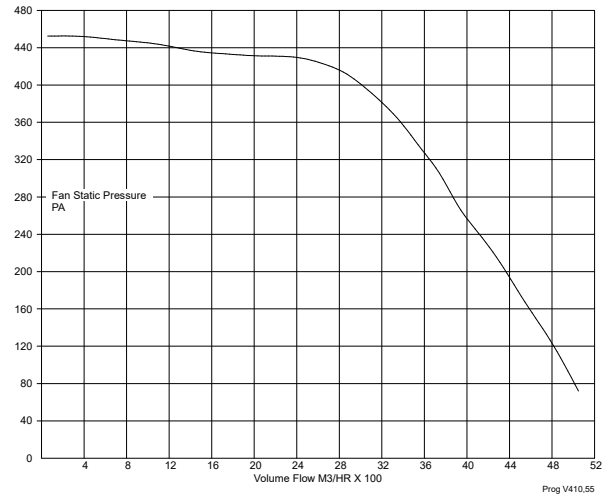

MKE-EP 450/4K A

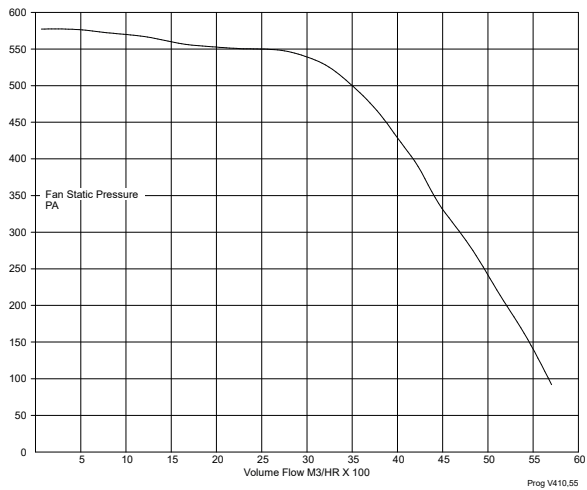

MKE-EP 450/4K B

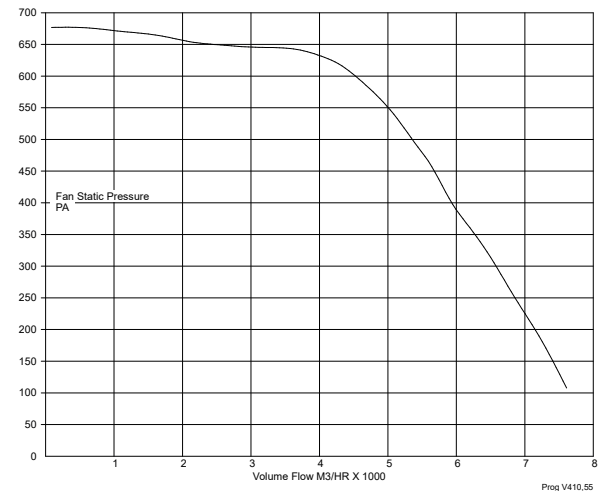

MKE-EP 500/4K

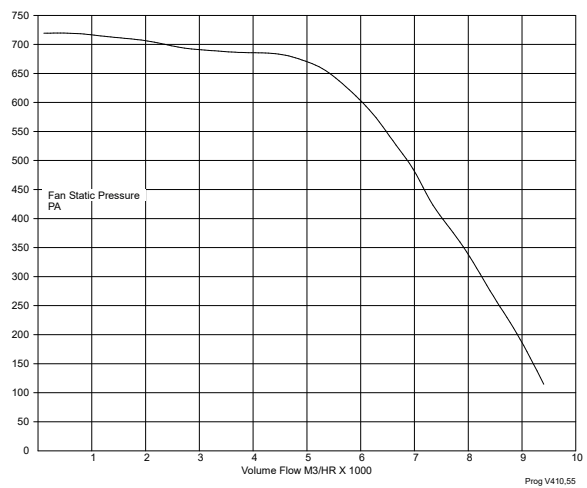

MKE-EP 560/4K A

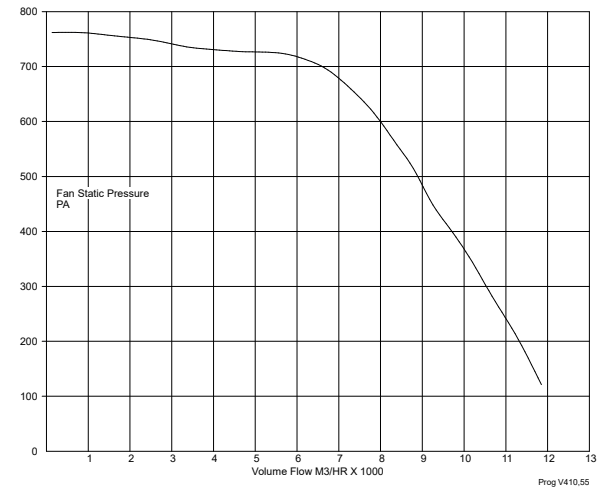

MKE-EP 560/4K B

Pressure Curves

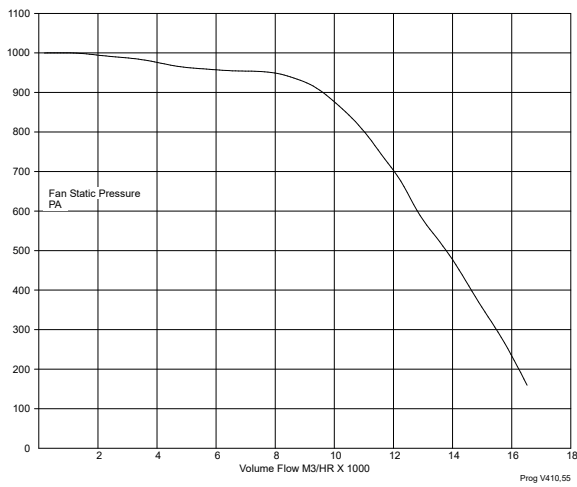

MKE-EP 630/4K

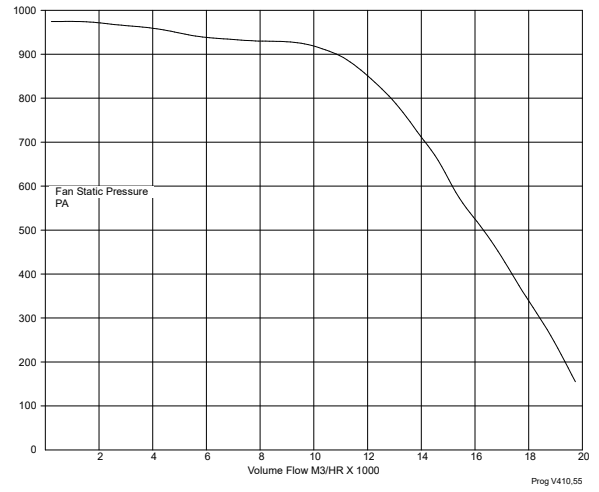

MKE-EP 710/4K A

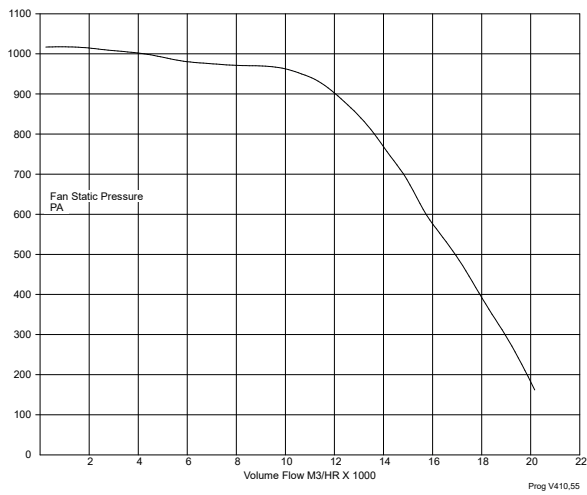

MKE-EP 710/4K B



MKE-KC

BOX FANS

MKE-KC Serie Exhaust fans can be used in narrow places with its compact frame where medium volume needs. Special designed impeller allows for high efficiency.

Technical Information

Model Type	Max m ³ /h	kW	rpm d/d	Hz	Voltage	Sound dB
MKE-KC 280	1100	0,18	1450	50	380	36
MKE-KC 315	1600	0,25	1469	50	380	38
MKE-KC 355	2300	0,37	1471	50	380	43
MKE-KC 400	3300	0,55	1478	50	380	45
MKE-KC 450	5000	0,75	1454	50	380	50
MKE-KC 500	7000	1,1	1462	50	380	53
MKE-KC 560	9800	1,5	1464	50	380	56,5
MKE-KC 630	14000	3	1465	50	380	59
MKE-KC 710	13000	4	950	50	380	55

Values are for 0 Pa.

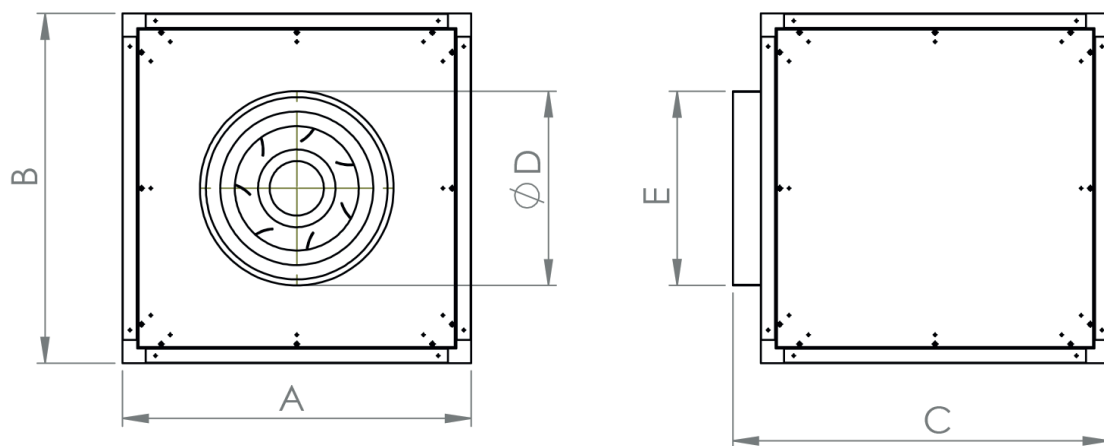

Model Type	A	B	C	D	E
MKE-KC 280	450	450	520	280	250
MKE-KC 315	500	500	570	315	300
MKE-KC 355	500	500	570	355	300
MKE-KC 400	600	600	600	400	350
MKE-KC 450	700	700	770	450	400
MKE-KC 500	800	800	870	500	450
MKE-KC 560	900	900	970	560	500
MKE-KC 630	1000	1000	1070	630	600
MKE-KC 710	1100	1100	1170	710	650

Pressure Curves

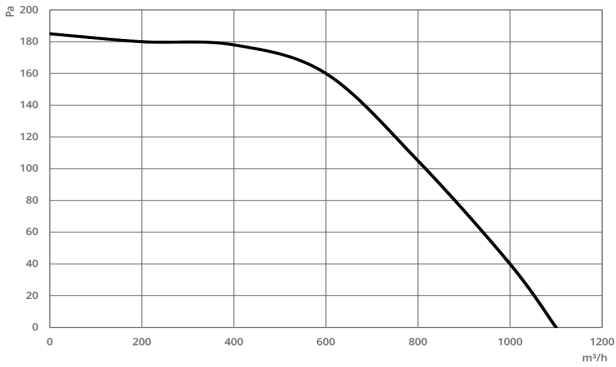

MKE-KC 280

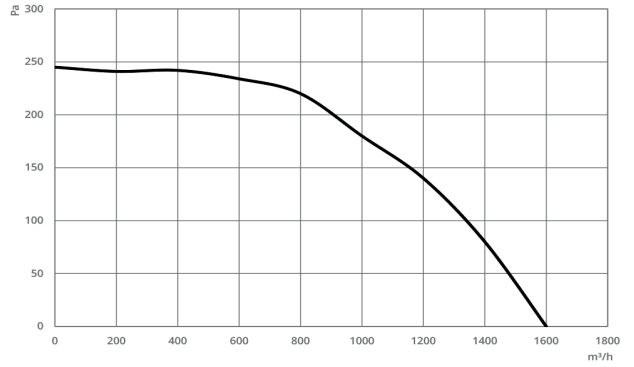

MKE-KC 315

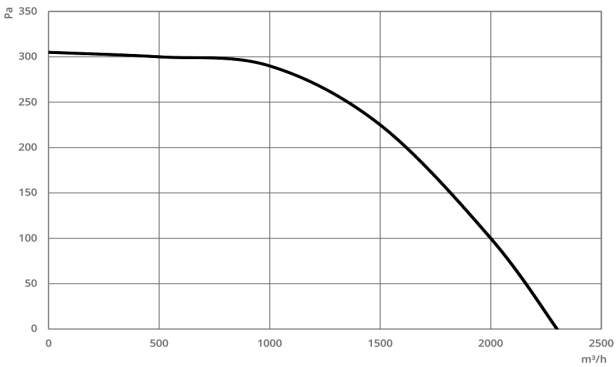

MKE-KC 355

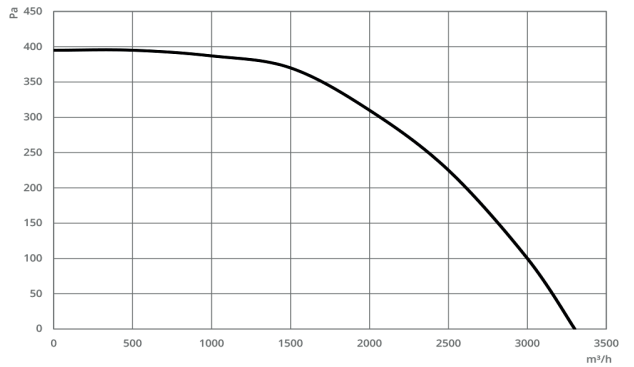

MKE-KC 400

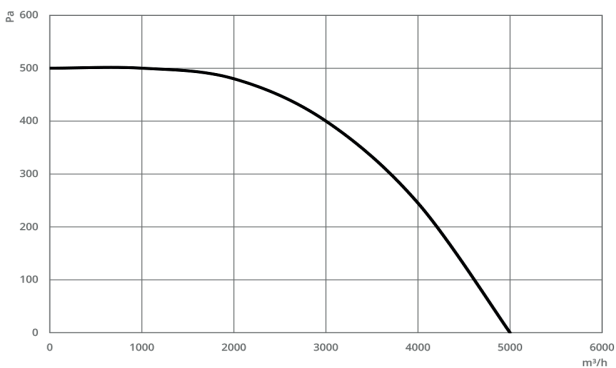

MKE-KC 450

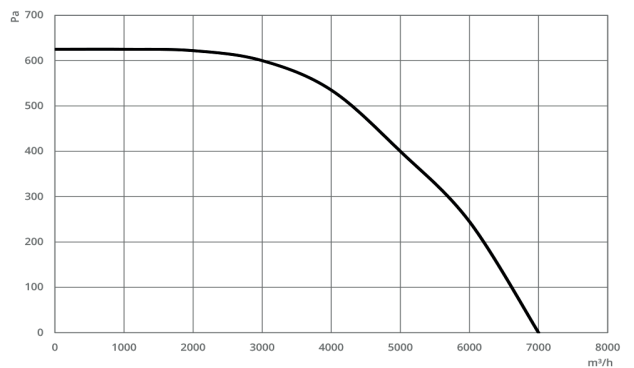

MKE-KC 500

Pressure Curves

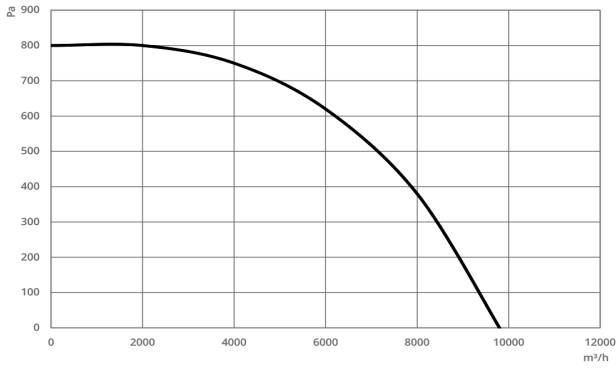

MKE-KC 560

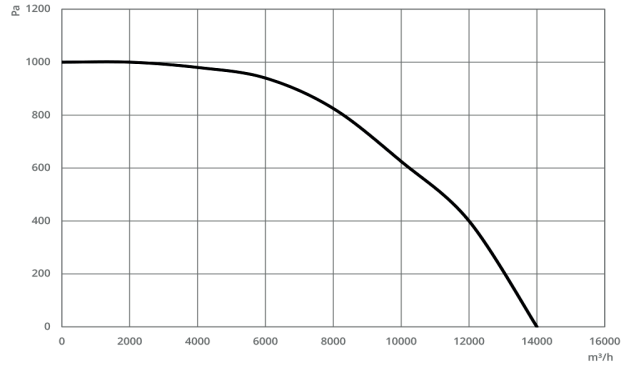

MKE-KC 630

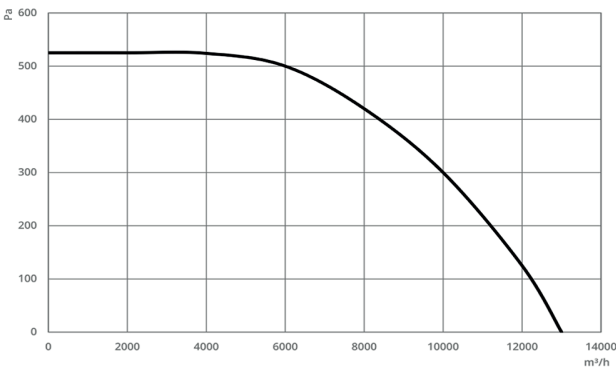

MKE-KC 710

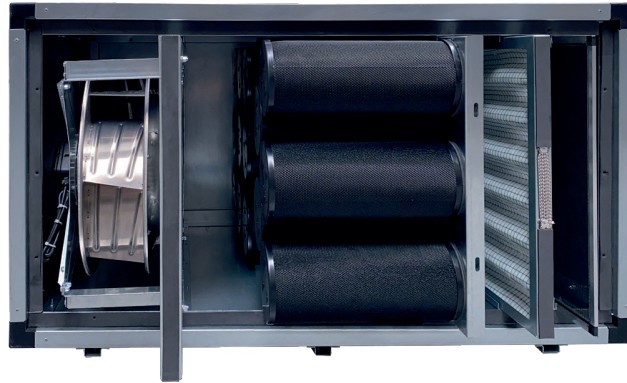

MKE-KCA

BOX TYPE KITCHEN EXHAUST FAN WITH ACTIVE CARBON FILTERS

MKE-KCA serie Exhaust fans are designed for industrial and commercial kitchens Easy cleaning and maintenance. Metal oil filter, G2 dust filter, Active carbon filter, included.

Technical Information

Model Type	Max m ³ /h	W	rpm d/d	Hz	Voltage	Sound dB
MKE-KCA 400	2400	380	1362	50	230	45
MKE-KCA 450	3300	690	1367	50	230	48
MKE-KCA 500	5200	830	1364	50	230-380	52
MKE-KCA 560	7200	1460	1369	50	380	55

Values are for 0 Pa.

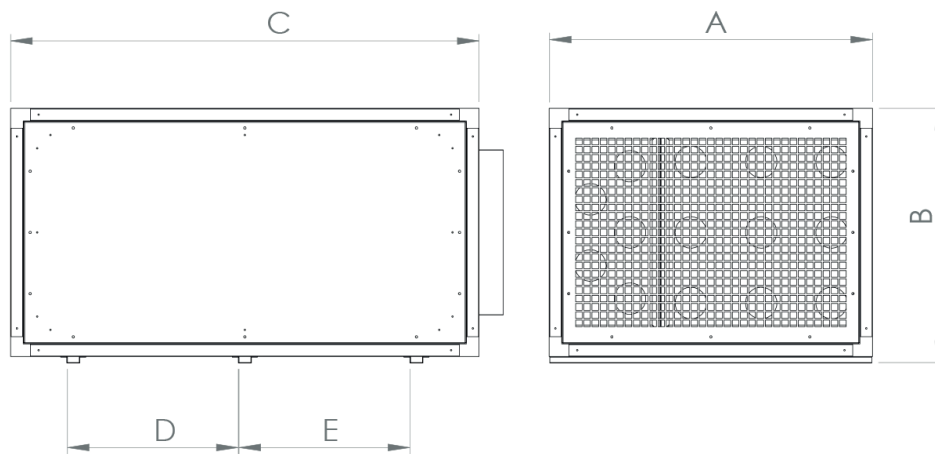

Model Type	A	B	C	D	E
MKE-KCA 400	665	750	1420	520	520
MKE-KCA 450	665	750	1420	520	520
MKE-KCA 500	980	750	1420	520	520
MKE-KCA 560	980	750	1420	520	520

Pressure Curves

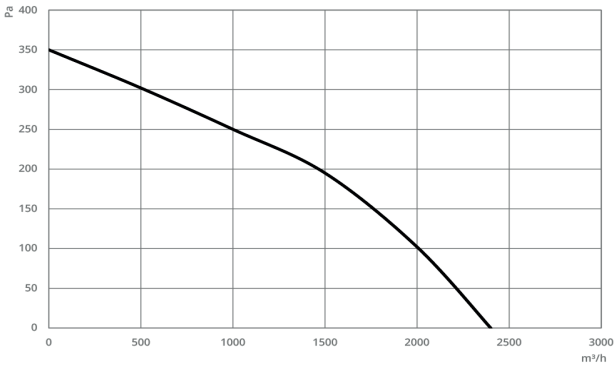

MKE-KCA 400

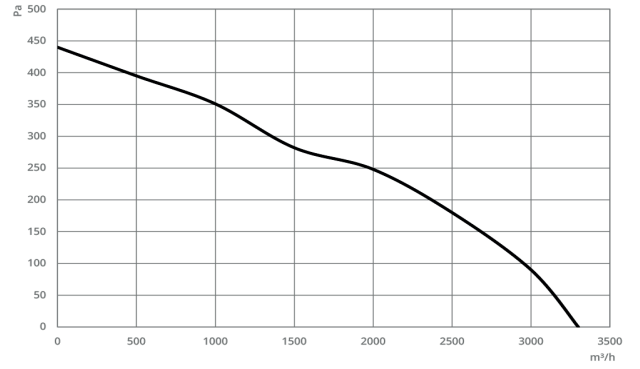

MKE-KCA 450

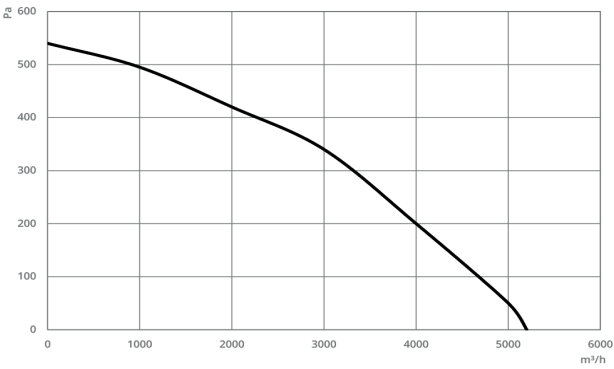

MKE-KCA 500

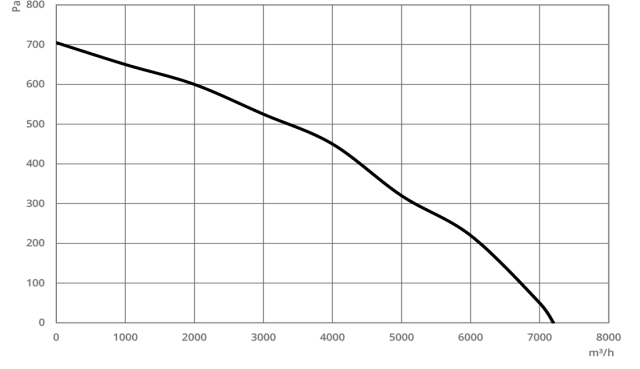

MKE-KCA 560

